



REORDER
FROM
ARGENT
LABORATORIES
TELEX: 269161 ACLI UR
FAX: (206) 885-2112
(800) 426-6258
(206) 885-3777

HATCHERY MANUAL
FOR THE
WHITE STURGEON
Acipenser transmontanus RICHARDSON
WITH APPLICATION TO OTHER
NORTH AMERICAN
ACIPENSERIDAE

The authors are Fred S. Conte, Aquaculture Specialist; Serge I. Doroshov, Professor, and Paul B. Lutes, Staff Research Associate, Department of Animal Science, University of California, Davis; and Elizabeth M. Strange, Staff Research Associate, Department of Wildlife and Fisheries Biology, University of California, Davis.

SH
351
.S79
H37
1988

For information about ordering this publication, write to:

Publications
Division of Agriculture and Natural Resources
University of California
6701 San Pablo Avenue
Oakland, California 94608-1239

or telephone (415) 642-2431

Publication **3322**

ISBN 0-931876-84-2
Library of Congress Catalog Card Number: 88-50176

©1988 by The Regents of the University of California
Division of Agriculture and Natural Resources

All rights reserved.

No part of this publication may be reproduced, stored in a retrieval system, or transmitted, in any form or by any means, electronic, mechanical, photocopying, recording, or otherwise, without the written permission of the publisher and the author.

Printed in the United States of America.

Production:

Louise Eubanks, Principal Editor;
Alfred L. Smith, Senior Artist.

CONTENTS

FIGURES		VII
TABLES		XIII
ACKNOWLEDGMENTS		XV
INTRODUCTION		1
SECTION I. Distribution and Natural History of North American Sturgeon and Paddlefish		3
Overview		3
White Sturgeon:		
<i>Acipenser transmontanus</i> Richardson		3
Green Sturgeon:		
<i>Acipenser medirostris</i> Ayres		3
Atlantic Sturgeon:		
<i>Acipenser oxyrinchus</i> Mitchill		4
Lake Sturgeon:		
<i>Acipenser fulvescens</i> (Rafinesque)		4
Shortnose Sturgeon:		
<i>Acipenser brevirostrum</i> (LeSueur)		4
Shovelnose Sturgeon:		
<i>Scaphirhynchus platyrhynchus</i> (Rafinesque)		5
Pallid Sturgeon:		
<i>Scaphirhynchus albus</i> (Forbes and Richardson)		5
Paddlefish:		
<i>Polyodon spathula</i> (Walbaum)		5
Status of Sturgeon and Paddlefish Species in the United States ..		5
SECTION II. Gamete Biology		9
Overview		9
Gametogenesis		9
Oogenesis		9
Mature Gametes and Fertilization		12
SECTION III. Embryology and Larval Development		15
Overview		15
Sturgeon Embryology:		
White Sturgeon, <i>A. transmontanus</i>		15
Unfertilized Egg		15
Fertilized Egg		15
Early Cleavage		15
Late Cleavage		16
Blastula		16
Early Gastrulation		16
Yolk Plug Formation		16
Neurulation		19
Elongation of the Pronephros		19
Heart Formation		19
Prehatch		19
Mass Hatching		20

	Larval Development at a Variable Temperature	
	Range of 16°–20°C (Beer 1981)	20
	One Day Posthatch	20
	Two Days Posthatch	20
	Three Days Posthatch	20
	Four Days Posthatch	22
	Five Days Posthatch	22
	Seven Days Posthatch	22
	Differentiation of the Pyloric Sphincter (Wang 1984)	22
	10 Days Posthatch	22
	13 Days Posthatch	22
	18 Days Posthatch	22
	20 Days Posthatch	23
SECTION IV.	Broodstock Capture	25
	Overview	25
	Fish from Nonspawning Areas	25
	Fish from Spawning Areas	26
	Methods of Broodstock Capture	26
	Snagging	26
	Baited Hooks	27
	Gill Net	27
	Handnetting	28
SECTION V.	Broodstock Handling, Transport, and Holding	29
	Overview	29
	Sturgeon Support Equipment: Individual	29
	Tube Net	30
	Stretcher	30
	Watertube	31
	Sturgeon Tanks and Applications	32
	Short-Term Holding	32
	Moderate-Term Holding and Transport	32
	Acclimation Tanks	33
	Maturation Tanks	34
	Spawning Tanks	34
SECTION VI.	Broodstock Evaluation: Field Examination	37
	Overview	37
	Field Evaluation of Broodstock:	
	Surgical Option	38
	Surgical Examination	38
	Staging the Male	39
	Staging the Female	39
	Postsurgical Procedures	39
	Determination of Potential Spawners:	
	Optional Test	41
	Field Evaluation: Broodstock from Spawning Areas	43

SECTION VII. Broodstock Evaluation: Hatchery	45
Overview	45
Nonripe Broodstock	45
Maturation Tanks	45
Establishing Dates for Final Selection and Spawning	45
Final Female Selection: Preassay Surgery	45
Assay for Determining Spawnable Females:	
Final Oocyte Maturation	46
Spawning Induction of Broodstock	47
Injection Schedule	47
Induction Hormones	47
Injection Procedures	48
Male Response	49
Female Response	49
SECTION VIII. Gamete Processing	51
Preparation of Materials for Egg De-Adhesion	51
Silt	51
Chemical De-Adhesion	51
Milt Extraction Overview	51
Milt Storage	52
Checking Sperm Viability	52
Sperm Dilution	54
Egg Extraction Overview	54
Female Sacrificed	54
Female Not Sacrificed	55
Egg Fertilization	57
Egg De-Adhesion	57
Measuring Total Spawn	58
SECTION IX. Incubation of Eggs and Early Life Stages	61
Overview	61
Incubation Equipment	61
Modified Trout Egg Barrel	61
Modified MacDonald Jar	62
Egg Incubation in the Modified Trout Egg Barrel	62
Egg Incubation in the Modified MacDonald Jar	63
SECTION X. Fingerling Production	67
Overview	67
Sturgeon Fry Transport	67
Sturgeon Fry Tanks	67

Circular Fry Tanks	67
Square and Rectangular Fry Tanks	67
Behavior of Young Fry	69
Initiation of Feeding	69
Selection of Food and Food Preference	70
Prepared Rations	70
Fry Feeding Rates and Feeding Frequency	70
Disease Treatments for Fingerling Sturgeon	72
Stocking Fingerling Sturgeon	72
APPENDIXES	75
1. Metric/English Conversion Table	77
2. Sturgeon Fisheries Statistics	78
3. Summary of Current Sturgeon Culture Techniques by Species	79
4. "Oviduct" Structure	82
5. Snagging Sturgeon	83
6. Salt Treatment for Sturgeon Broodstock and Large Fingerlings	83
7. Identification of Female White Sturgeon Before Reproductive Migration	84
8. Use of Nitrofurazone as a Disinfectant	84
9. Classification of Gametogenic Stages in the White Sturgeon	85
10. Incubation Medium	86
11. Suture Materials	86
12. Oocyte Maturation	87
13. Surgical Equipment	87
14. Maturation Steroid Progesterone	87
15. Spawning Induction Substances	88
16. Spawning Induction of Sturgeon with LHRHa	88
17. Cryopreservation	89
18. Mechanical Siltation	89
19. Fry Rations Combined with Natural Foods	90
REFERENCES	91
General References	93
Section References	103

Trade and company names mentioned in this publication are for informational purposes only. It does not imply University of California or U.S. Government endorsement of the product. All uses of fishery compounds must be registered by appropriate State and Federal agencies. Only those uses described on the label are permitted and only at the rates listed.

FIGURES

- Figure 1. Diagram of (a) cross-section 10-18 cm behind the pectoral fin of a female sturgeon showing position of gonad in the body cavity and (b) detail showing oocytes in relation to the ovarian wall and coelomic cavity.
- Figure 2. Diagram of the sturgeon oocyte in cross-section showing (a) the preovulatory oocyte with follicular envelope and (b) the disassociation of the follicular envelope and the release of the oocyte into the coelomic cavity.
- Figure 3. Schematic representation of white sturgeon egg before (0 min.) and after (30 min.) freshwater exposure, showing the four layers of the egg envelope: J (jelly layer), L3 (layer containing ducts, or micropyles), L2 (layer containing bioscrews that anchor L3), and L1 (layer immediately surrounding the oolemma). A, animal pole; V, vegetal pole. (Cherr et al., 1985)
- Figure 4. Scanning electron micrograph of white sturgeon egg demonstrating the bioscrews (arrows) of L2 that anchor L3 and the jelly to the egg. 2500X. (Cherr et al., 1985)
- Figure 5. Scanning electron micrographs of white sturgeon egg. (a) Egg surface with jelly removed, showing micropyles at the animal poles. 500X. (b) Fracture through a micropyle down to L1, showing micropyle extension to the oolemma. 1800X. (Cherr et al., 1985)
- Figure 6. Schematic diagram of white sturgeon spermatozoa. A, acrosome; N, nucleus; MP, midpiece; F, flagellum. (Cherr et al., 1985)
- Figure 7. Scanning electron micrograph of a white sturgeon egg one minute after insemination with white sturgeon sperm (10^3 sperm/egg). (a) Surface scan with jelly layer removed, showing micropyles and numerous sperm. 500X. (b) Higher magnification of a single micropyle with numerous sperm. 2500X. (Cherr et al., 1985)
- Figure 8. White sturgeon embryo, early cleavage, four blastomeres. (Beer 1981)
- Figure 9. White sturgeon embryo, early cleavage, eight blastomeres. (Beer 1981)
- Figure 10. White sturgeon embryo, advanced cleavage, with numerous micromeres in animal hemisphere and larger macromeres in the vegetal hemisphere. (Beer 1981)
- Figure 11. White sturgeon embryos, various stages of late cleavage. (Beer 1981)
- Figure 12. White sturgeon embryo, showing the future dorsal lip as a narrow pigmented line. (Beer 1981)
- Figure 13. White sturgeon embryo, early gastrulation, showing involution of cells that will result in the formation of the gastrocoele. (Beer 1981)
- Figure 14. White sturgeon embryology. (Wang 1984)

CLVG	= Early cleavage	GSTR	= Gastrulation
NEUR	= Neurulation	S-HRT	= Formation of the heart
HATCH	= Recently hatched sturgeon		
PY-SPH	= Formation of the pyloric sphincter		
Y-DPL	= Stage of yolk depletion		

- Figure 15. White sturgeon embryo, yolk plug formation. (Beer 1981)
- Figure 16. White sturgeon embryo, late yolk plug stage, with indication of the embryonic axis. (Beer 1981)
- Figure 17. White sturgeon embryo, early neurulation showing the neural groove. (Beer 1981)
- Figure 18. White sturgeon embryo, neural tube formation. (Beer 1981)
- Figure 19. White sturgeon embryos, various stages of neurulation showing body definition. (Beer 1981)
- Figure 20. White sturgeon embryo, elongation of the pronephros and protrusion of the embryonic body above the yolk sac surface. (Beer 1981)
- Figure 21. White sturgeon embryos just before hatch, showing differentiated embryos enclosed in egg membranes. (Beer 1981)
- Figure 22. White sturgeon embryo just before hatch, showing the tail extending past the head and lying against the yolk surface. (Beer 1981)
- Figure 23. White sturgeon hatching from the egg tail first. (Beer 1981)
- Figure 24. Newly emerged white sturgeon. (Beer 1981)
- Figure 25. White sturgeon, 2 days posthatch. (Beer 1981)
- Figure 26. White sturgeon, 10 days posthatch. (Beer 1981)
- Figure 27. White sturgeon, 18 days posthatch. (Beer 1981)
- Figure 28. Loading captured sturgeon aboard collection boat.
- Figure 29. Transfer of sturgeon between capture boat and processing boat.
- Figure 30. White sturgeon in holding tank aboard small boat.
- Figure 31. Snagging sturgeon, San Pablo Bay, California.
- Figure 32. Sturgeon snagging gear showing hooks, leader, and weights.
- Figure 33. Handnetting lake sturgeon broodstock. (Photo courtesy of the Wisconsin Department of Natural Resources)
- Figure 34. Power sling and weight scale used for large Atlantic sturgeon broodstock. (Photo courtesy of the South Carolina Department of Natural Resources and the U.S. Fish & Wildlife Service)
- Figure 35. Tube net used to capture and restrain intermediate-sized sturgeon broodstock.
- Figure 36. Transferring sturgeon broodstock from a tube net to a stretcher.
- Figure 37. Transporting sturgeon broodstock to a work area by stretcher.

- Figure 38. Sturgeon stretcher positioned on a notched sawhorse.
- Figure 39. Close view of watertube and stretcher hood in use.
- Figure 40. Close view of watertube extending through the stretcher hood and into the sturgeon's mouth.
- Figure 41. Fiberglass holding tank for holding sturgeon females during hormone-induced ovulation.
- Figure 42. Double-sided fiberglass holding tank used to maintain two individual sturgeon females during observation.
- Figure 43. Insulated fiberglass transport tank for sturgeon broodstock mounted on a double-axle trailer and equipped with a water circulation system and supplementary aeration.
- Figure 44. Fiberglass acclimation tank for sturgeon captured in salt water.
- Figure 45. Six-meter diameter fiberglass tank with peaked fiberglass sectional roof used for long-term holding and as maturation tanks for sturgeon broodstock.
- Figure 46. Three and a half-meter fiberglass tank with screen roof used to maintain sturgeon broodstock.
- Figure 47. Fiberglass tank with plywood cover used to spawn sturgeon broodstock.
- Figure 48. Initial incision made during the surgical examination of sturgeon broodstock.
- Figure 49. Diagrams of cross-section through lower third of body of sturgeon broodstock showing the position of the gonads in (a) mature female and (b) mature male.
- Figure 50. Removal of an oocyte sample from the body cavity of a female sturgeon by the aspiration technique using a tygon tube inserted through an incision in the body wall.
- Figure 51. Close view of the tygon tube used to remove an oocyte sample from a female sturgeon.
- Figure 52. Suturing a broodstock sturgeon following surgical examination.
- Figure 53. Suture patterns used to close incisions made during the surgical examination of sturgeon broodstock.
- Figure 54. Cattle leg-band used to tag sturgeon broodstock.
- Figure 55. Tagging instrument with numbered spaghetti tags used to tag sturgeon broodstock.
- Figure 56. Sturgeon oocyte samples in beakers containing Leibovitz incubation medium boiling on hot plates.

- Figure 57. Sturgeon oocyte samples chilled on ice in beakers containing Leibovitz incubation medium.
- Figure 58. Bisecting a single white sturgeon oocyte along the animal-vegetal axis to determine the position of the germinal vesicle (GV).
- Figure 59. Six bisected white sturgeon oocyte samples used to determine the position of the germinal vesicle (GV). The GV can be seen in each sample as a dark sphere or smear in the cytoplasm or near the internal margin of the oocyte.
- Figure 60. Diagram of a sturgeon oocyte showing the position of the germinal vesicle (GV) in the cortical ooplasm of the animal pole and formula for determining stage. (Modified from Detlaf et al., 1981)
- Figure 61. Adding predissolved progesterone maturation steroid stock solution to culture plates containing sturgeon oocytes and Leibovitz incubation medium.
- Figure 62. Injecting sturgeon broodstock with spawning-induction hormone.
- Figure 63. Large syringe fitted with a piece of tygon tube used to remove milt from male sturgeon.
- Figure 64. Removing milt from a male sturgeon.
- Figure 65. Close view of use of syringe to remove milt from a male sturgeon.
- Figure 66. Syringes containing sturgeon milt ready for storage at 4°C.
- Figure 67. Cutting an "X" in the paraffin seal to allow oxygen exchange in a container of sturgeon milt. The containers are embedded in a tray of ice for rapid chilling before storage at 4°C.
- Figure 68. Prior to storage at 4°C, the ice tray containing sturgeon milt samples is enclosed in a plastic bag that is inflated with pure oxygen and sealed.
- Figure 69. Sacrificed female white sturgeon in preparation for egg removal.
- Figure 70. A female paddlefish positioned on her back with belly cut to show the ovarian mass.
- Figure 71. Insertion of a knife point into the vent of a female white sturgeon, with the cutting edge facing outside, begins the process of egg removal.
- Figure 72. The cut is extended upwards while a bowl is positioned near the bottom to catch the eggs.
- Figure 73. Care is taken to assist removal of loose sturgeon eggs from the ovarian mass forced out of the cut by gravity.
- Figure 74. The cut is extended to expose the total sturgeon egg mass. All loose eggs are carefully hand-combed from the ovarian mass and body cavity.

- Figure 75. Surgery for egg removal being performed on a live female white sturgeon to be retained for broodstock.
- Figure 76. Eggs being spooned out of a live female white sturgeon. Later the female will be sutured and allowed to recover in a holding tank.
- Figure 77. Fertilization of sturgeon eggs by adding diluted milt to a bowl of eggs and slowly mixing with a soft instrument or by hand.
- Figure 78. Fertilized sturgeon eggs undergoing de-adhesion by hand-mixing with river silt.
- Figure 79. Pouring off the suspension of river silt during de-adhesion of sturgeon eggs.
- Figure 80. Adding a fresh silt suspension during de-adhesion of sturgeon eggs.
- Figure 81. Hand-counting sturgeon egg samples from a known volume to obtain an estimate of the total spawn.
- Figure 82. Modified trout egg barrel used in two-stage incubation systems to incubate sturgeon eggs until the neurulation stage of early embryonic development.
- Figure 83. Diagram of a sturgeon hatchery system using modified MacDonald jars. UV = ultraviolet treatment. (Monaco and Doroshov 1983)
- Figure 84. Diagram of a sturgeon hatchery system showing water flow scheme. (Monaco and Doroshov 1983)
- Figure 85. Spray-bar aeration system in header box and attached UV unit of a sturgeon hatchery system.
- Figure 86. Modified MacDonald jars showing the clear acrylic sleeve extending to the bottom of the jar and covering the water delivery pipe cut at a 60-degree angle.
- Figure 87. Loading the modified trout egg barrel with fertilized sturgeon eggs that have undergone de-adhesion.
- Figure 88. A 3.0-mm mesh screen used to cap the modified trout egg barrel and prevent sturgeon eggs from flowing out with the discharge water.
- Figure 89. Modified MacDonald jars loaded with sturgeon eggs before initiation of water flow. (Photo by Jack Kelly Clark)
- Figure 90. Close view of eggs in modified MacDonald jars before initiation of water flow.
- Figure 91. Sturgeon eggs in modified MacDonald jars after water flow is initiated. (Photo by Jack Kelly Clark)
- Figure 92. A sturgeon hatchery system showing the use of extension tubes to direct water flow from the hatchery jars to the water recirculation system, the larval collecting tank, or a silt sump.

- Figure 93. Sturgeon larval collecting tanks receiving water flow and fry from the hatchery system.
- Figure 94. White sturgeon fingerlings prepared for shipment in plastic bags.
- Figure 95. Oxygen inflation of double plastic bag containing water and white sturgeon fingerlings for transport.
- Figure 96. Circular fiberglass tanks used to rear sturgeon fry.
- Figure 97. Close view of spray-bar water delivery system used in circular fry tanks.
- Figure 98. Rectangular fry tank used in sturgeon culture. (Photo courtesy of Arrowhead Fishery, Gerber, California)
- Figure 99. Six-day posthatch sturgeon fry exhibiting negative phototaxis, settling to the bottom of the tank, and aggregating in clumps.
- Figure 100. Thirteen-day posthatch sturgeon fry terminating clumping behavior and scattering throughout water column.
- Figure 101. Closer view of sturgeon following clump dispersal and initiation of feeding.
- Figure 102. Circular fiberglass tanks stocked with a low density of advanced sturgeon fingerlings ready for stocking.
- Figure 103. Schematic diagram of the white sturgeon's oviduct, including the relationship of the paramesonephric duct and kidney (Appendix 4).

TABLES

- Table 1. Summary of selected biological data for the North American Acipenseriformes.
- Table 2. Rate of embryonic development for white and lake sturgeon at 15°C incubation temperature.
- Table 3. Suggested water-quality criteria for a sturgeon hatchery.
- Table 4. Equipment used for field examination of sturgeon broodstock.
- Table 5. Gross characteristics of ovaries and testes of white sturgeon notable during surgical examination.
- Table 6. Classification of late-stage maturity of oocytes based on oocyte polarization and germinal vesicle migration.
- Table 7. Equipment used for hatchery examination of sturgeon broodstock.
- Table 8. Level of sedation and corresponding response of sturgeon anesthetized with MS-222.
- Table 9. Dose for exogenous hormone common carp pituitary (CCP) to induce spawning in white sturgeon.
- Table 10. Equipment used for gamete processing.
- Table 11. Research protocol: commercial rations developed for salmonids and currently used for feeding of larval and fingerling sturgeon at UC Davis.
- Table 12. Commercial hatchery protocol: commercial rations developed for salmonids and currently used for feeding larval and fingerling sturgeon cultured in North America.
- Table 13. Common treatments used to control diseases observed among cultured white sturgeon.
- Table 14. Unidentified diseases and diseases with no developed treatment to date.

ACKNOWLEDGMENTS

This manual was produced through a grant (14-16-009-83-036) provided by the United States Fish and Wildlife Service (USFWS), administered through the USFWS Office of Extension and Publications.

Acknowledgments are extended to the following institutions and agencies whose contributions were essential to production of the manual: the Aquaculture and Fisheries Program, University of California, Davis; the South Carolina Marine Resources Research Institute; the Wisconsin Department of Natural Resources; and the National Marine Fisheries Service.

Special acknowledgments are extended to the following individuals whose efforts contributed significantly to the completion of the manual: Nicole A. Gibson and Jack Kelly Clark, Cooperative Extension, University of California (UC); Ann B. McGuire, Science Editor, Atlanta, Georgia; Peter B. Moyle, Silas S. O. Hung, Ronald P. Hedrick, Frank A. Chapman, Gary N. Cherr, Clark E. Bordner, William T. Walsh, Lucy Z. Garcia, Jan Campbell, Robert Pipkin, and Joan C. Lindberg, UC Davis; Duncan McDonald and Curt Burley, U.S. Fish and Wildlife Service; and Hank McAvoy, National Marine Fisheries Service.

Sincere appreciation is extended to Phil Mackey, Keith Brown, and Tony Vaught of Arrowhead Fishery, Gerber, California, and to Ken Beer and Ken Lawson of The Fishery, Sacramento, California, for their contributions to and review of this manual.

INTRODUCTION

The first successful, large-scale finfish hatchery programs in the United States were established by federal and state agencies given the responsibility for our natural resources. These programs were established to replenish commercial and sports fisheries that were in decline due to overexploitation, environmental degradation, or loss of habitat caused by other human activities near and in water environments. Although the impact of hatchery-produced finfish on natural populations is controversial, salmon and trout fisheries would not exist under contemporary pressure without hatchery supplementation. Ideally fisheries-mitigation programs would be multifaceted, encompassing protection of the integrity of natural stocks, environmental restoration and protection, and hatchery supplementation where necessary. In some instances in which species are threatened or endangered, hatchery production may play a significant role in maintaining these populations.

Sturgeon stocks have experienced worldwide decline not only because of the impact of human activities on sturgeon habitat, but also because of the high value of the fish flesh and the caviar produced from the eggs. Fishing pressure combined with environmental pressure from dam construction and development of adjacent watersheds are the major factors contributing to stock decline. Historically, sturgeon products have been considered valuable in Europe, Asia, and North America. Before 1900 the United States sturgeon landings were estimated to be 15 million pounds on the East Coast and 10 million pounds on the West Coast. Today the U.S. commercial fishery is small and consists primarily of white and Atlantic sturgeon (see Appendix 2 for sturgeon fishery statistics).

The international demand for sturgeon, both for its flesh and for its caviar, has always placed pressure on the world's sturgeon fisheries. The decline in sturgeon stocks was recognized in Russia and the United States in the second half of the 1800s, and the first recorded attempts at artificial propagation of sturgeon were made by Ovsyanikov in Russia (1870) and by Green in the United States (1875). Programs to artificially propagate sturgeon were established in North America, and significant efforts were made between 1875 and 1912 to develop hatchery technology for Atlantic, and lake sturgeon. A few efforts were made after 1912, but by 1920 serious interest in artificial propagation of sturgeon in North America was abandoned.

Sturgeon hatchery research continued in the Soviet Union, however, and was accelerated during

the 1950s as part of mitigation programs to compensate for habitat alterations. Technical obstacles to artificial propagation were overcome, and currently the U.S.S.R. operates approximately 20 hatcheries and releases 70 to 100 million fingerlings annually. These programs reportedly have restored the sturgeon fisheries of three species to historical levels and currently contribute 75 percent of the world's sturgeon catch. The annual international sturgeon fishery landings today are between 20,000 and 40,000 metric tons and are primarily located in the Soviet Union and Iran. The success of the sturgeon mitigation programs in the Soviet Union stimulated interest in reinitiating sturgeon research in the United States, and the work of Detlaf, Gerbilsky, Ginzburg, Kozin, and their associates provided an information base that has allowed rapid progress for sturgeon programs in North America.

In 1979 a grant from the U.S. Fish and Wildlife Service to researchers at the University of California led to a resurgence of sturgeon research in the United States. Currently, efforts on the West Coast, in the Great Lakes area, and on the East Coast have accelerated both hatchery and fisheries research, with the ultimate objective of rebuilding U.S. sturgeon populations. The development of hatchery technology for the white sturgeon has allowed creation of a growing commercial sturgeon aquaculture industry on the West Coast, and initial plants of hatchery-produced stocks have been made through efforts of federal and state agencies in cooperation with universities and private industry.

This resurgence in sturgeon research and the successes in hatchery development have created a need for transfer of technical information to public and private sector aquaculturists. The information in this manual is based primarily on techniques developed for hatchery production of white sturgeon at the University of California at Davis but can be applied to all North American *Acipenseriformes*. Modifications of the techniques will be employed as more information is developed. This technology demonstrates great potential for full hatchery system development and the production of fingerlings in sufficient numbers for mitigation programs and commercial production in the United States. Many of the same techniques described are used in institutional and agency hatcheries in Wisconsin and South Carolina for the lake, Atlantic, and shortnose sturgeons, and for paddlefish in Missouri (for a summary of culture techniques by species, see Appendix 3).

Information for use in this manual has been provided by all of these research units and by commercial hatcheries in California.

The manual is organized to provide basic information on the biology of North American Acipenseridae in the early sections, followed by sections containing specific information on practical hatchery techniques. The basic information covers the natural distribution of the species and biological information on sturgeon that will make clear why particular techniques are used in the manual.

The Appendixes begin with a conversion table for English and metric units (Appendix 1) and present additional information on specific subjects, including additional techniques used by sturgeon hatcheries across the United States. Although the manual focuses on the white sturgeon, specific hatchery information on the lake, Atlantic, green, pallid, shovelnose, and shortnose sturgeon and the paddlefish is summarized in Appendix 3.

The manual contains two reference sections, a comprehensive reference list (General References) and a numerical list of those specific references from the general reference list that pertain to each section of the manual (Section References). This approach was used to provide the maximum information to hatchery personnel. In addition to the specific references used in the manual sections, the General References list contains additional citations that contain valuable information for sturgeon biologists.

As with all technologies, this information will be refined, further developed, and altered as requirements are identified for specific species at specific locations. The manual should be viewed as providing a base of practical hatchery information for sturgeon that may be modified to fit different hatchery needs and different requirements of other species of sturgeon as the information is developed. This manual is a beginning for North American species, and we wish to thank all who contributed to its production.

SECTION I

Distribution and Natural History of North American Sturgeon and Paddlefish

Overview

Sturgeon belong to the family Acipenseridae and paddlefish to the family Polyodontidae. Seven species of sturgeon and one species of paddlefish are found in North America: the white sturgeon (*Acipenser transmontanus*), the green sturgeon (*A. medirostris*), the Atlantic sturgeon (*A. oxyrinchus*), the lake sturgeon (*A. fulvescens*), the shortnose sturgeon (*A. brevirostrum*), the shovelnose sturgeon (*Scaphirhynchus platyrhynchus*), the pallid sturgeon (*S. albus*), and the American paddlefish (*Polydon spathula*). A summary of selected biological data for each species is presented in table 1 at the end of this section.

Sturgeon and paddlefish are a primitive stock of teleost fish that evolved approximately 250 million years ago. They are chondrosteian fish of the order Acipenseriformes, and representatives are known for their longevity and large size. These fish are distinguished from modern teleosts by a skeleton that is mostly cartilaginous, a notochord that persists into adulthood, primitive fin and jaw structures, a spiral valve intestine, and a heterocercal tail. Most sturgeon species have a spiracle. Sturgeon have five rows of large, dermal bony plates, or scutes, and some ganoid scales. Their protrusible mouths draw in benthic organisms detected by sensitive barbels beneath their snouts. The American paddlefish has scales on the upper lobe of the caudal fin, like the sturgeon, but possesses a smooth, scaleless body, and is a filter feeder.

Sturgeon and paddlefish inhabit temperate waters in northern Europe, Asia, and North America. They include anadromous, semianadromous, and freshwater forms, and all species spawn in freshwater. A relatively small number of sturgeon are truly anadromous, as defined by living exclusively in a marine environment and returning to freshwater only to spawn. The best examples of anadromous North American sturgeon are the green sturgeon and the Atlantic sturgeon. White sturgeon are best defined as semianadromous. They live primarily in estuaries of large rivers, are euryhaline, and often form landlocked stocks in lakes and reservoirs. Sturgeon are iteroparous, spawn several times in a lifetime, and females spawn at intervals ranging from 2 to 8 years. Mature adults participate in a seasonal upstream migration, and reproductively active fish usually

spawn in areas of swift current. The relatively large eggs are demersal and adhesive, and fertilized eggs undergo holoblastic cleavage.

White Sturgeon: *Acipenser transmontanus* Richardson

The white sturgeon inhabits drainage systems of the Pacific coast of North America from the Aleutian Islands of Alaska south to Ensenada, Mexico. It is found in salt, brackish, and freshwater. Although some populations may be considered anadromous, others remain in freshwater year-round. A landlocked population is known in the upper Columbia River, and there are indications of one in California's Lake Shasta.

The white sturgeon is usually uniformly gray and is identified by the arrangement of its four barbels in a transverse row beneath a short, broad snout, with the barbels closer to the tip of the snout than to the mouth, and by its 38 to 48 lateral bony plates.

In fall and winter, anadromous and semi-anadromous adults leave the ocean and estuaries and ascend upstream to spawn. Downstream migration occurs in late spring and summer. Spawning is thought to occur in areas of deep gravel riffles, in deep holes, and over rocky bottoms in areas of swift current. Like other sturgeon, white sturgeon feed on an array of benthic invertebrates, but the larger individual fish are piscivorous.

Green Sturgeon: *Acipenser medirostris* Ayres

The green sturgeon is found in North America and Asia. The Asian populations are in China, northern Japan, Korea, and the Soviet Union, and the North American populations are in coastal areas from the Gulf of Alaska to southern California. Green sturgeon are anadromous but are rarely seen in freshwater. They do migrate long distances up freshwater rivers to spawn but are more commonly found in bays, sounds, and the lower reaches of large rivers.

The green sturgeon is similar in appearance to the white sturgeon, and the two species are often found together along the west coast of North America. In contrast to the white sturgeon, the four barbels are nearer the mouth than to the tip

of the snout, and the snout is more elongated and narrower, appearing concave in profile. There are 23 to 30 lateral bony plates. The green sturgeon does not grow as large as the white sturgeon. It has a characteristic dark green to olive green color and olive green longitudinal stripes along each side.

The green sturgeon is less abundant than the white sturgeon and spends more time at sea. Its life history is largely unknown but is believed to be similar to that of the white sturgeon. It can be found at the mouths of rivers in August and September and appears to move into freshwater in the fall and winter prior to spawning in the spring.

Atlantic Sturgeon:

Acipenser oxyrinchus Mitchill

There are two subspecies of Atlantic sturgeon, *Acipenser oxyrinchus oxyrinchus* and *A. oxyrinchus desotoi*, the latter also known as the Gulf of Mexico sturgeon. Historically *A. o. oxyrinchus* was found along the Atlantic coast of North America from the Hamilton River in Labrador, Canada to eastern Florida, and *A. o. desotoi* was reported to inhabit the Gulf of Mexico, Bermuda, and the northern coast of South America. Today populations of the two subspecies are sharply reduced. *A. o. oxyrinchus* occurs from Labrador to northeastern Florida, and *A. o. desotoi* is confined to the northeastern Gulf of Mexico, from the Mississippi Delta east to the Suwannee River in Florida.

The Atlantic sturgeon is brownish black on the back and top of the head, pale on the sides, and whitish underneath, with 24 to 35 lateral plates.

Both subspecies are anadromous. Juvenile Atlantic sturgeon inhabit the lower reaches of rivers and estuarine areas until migrating to sea at 4 to 6 years of age. They continue their growth to maturity at sea, and reproductively active adults move to freshwater for spawning. Spawning occurs in rivers at water temperatures ranging from 13 to 18°C at depths of 11 to 13 meters, usually in areas of turbid water over hard, clay substrate.

Atlantic sturgeon generally remain near the rivers where they spawn until they migrate to sea. While in freshwater, the young feed on aquatic insects, amphipods, oligochaetes, and *Pisidium*. In the sea, adults consume gastropods, shrimp, amphipods, and small fish, especially sand lances, *Ammodytes*.

Lake Sturgeon: *Acipenser fulvescens* (Rafinesque)

The lake sturgeon is found in many of the large lakes and rivers of Canada and the United States.

In Canada it is found as far north as the Seal River on the west coast of Hudson Bay in Manitoba, and its range also extends from the Brazeau River in Alberta east to Cape Brule in the St. Lawrence Estuary in Quebec. In the United States it is found in lakes and rivers in a triangular-shaped area that extends west of the Appalachians, south to the Coosa River system of Alabama, across southern Arkansas, and northwest following a line through the Missouri River.

The lake sturgeon is a freshwater species, but in Canada it is occasionally found in brackish water. It is usually brownish or gray above and white or mottled underneath, with 30 to 38 lateral plates. It prefers shallow water and is usually found at depths of less than 4.5 meters over mud or gravel bottoms in lakes or large rivers. Its diet is primarily benthic macroinvertebrates, especially insect larvae. Winters are spent in relative inactivity in deep, well-aerated pools.

In early spring, lake sturgeon migrate to smaller rivers or very shallow areas of lakes to spawn. They reportedly move in mixed groups of individuals of different ages, sizes, and stages of maturity. When close to shore, lake sturgeon spawn near the surface but more commonly spawn in river rapids less than 4.5 meters deep or at the base of falls. During spawning, females have been observed lying together in groups of two or three with one or two males accompanying each female.

Shortnose Sturgeon: *Acipenser* *brevirostrum* (LeSueur)

The shortnose sturgeon ranges along the eastern coast of North America from the St. John River in New Brunswick, Canada, south to the St. Johns River in eastern Florida. It is considered endangered in the United States. Over the past 35 years, sightings of shortnose sturgeon have come from the St. John River, Canada, the Sheepscot and Kennebec Rivers in Maine, the Hudson River in New York, the Connecticut River in Massachusetts, the Altamaha River in Georgia, most larger rivers in South Carolina, and the St. Johns River in Florida. It prefers coastal river systems but can also move into brackish and fully marine conditions.

Some populations, like that of the St. John River, migrate to more saline areas only on a seasonal basis, whereas others are more truly anadromous, spending a significant portion of their lives at sea. Gulf of Maine shortnose sturgeon appear to travel to sea some distance from the home stream, but in general this species is not as migratory as other sturgeon. A landlocked population is known from the Holyoke Pool of the Connecticut River.

As its name suggests, the shortnose sturgeon

is characterized by a short, blunt snout. The lateral scutes are clearly paler than the background. The head and back are dark, the underside is white, and the mouth is wide. Young shortnose sturgeon have very small, conical teeth and are thought to feed on protozoa, crustacea, and small insects. The adults feed primarily on molluscs. They assume adult body proportions at about 61.0 cm total length. Shortnose sturgeon spawn in freshwater in the spring, usually over rubble in areas of swift current.

Shovelnose Sturgeon: *Scaphirhynchus platyrhynchus* (Rafinesque)

The shovelnose sturgeon is found throughout much of the Mississippi and Missouri Rivers and in portions of their larger tributaries. It extends northwest through Montana, eastward into Pennsylvania, and south to the Mississippi Delta. Although it was once common throughout its range, its current numbers are small. The species tolerates high turbidity and is usually found in river channels in areas of strong current. Their diet is composed mostly of aquatic insect larvae.

The shovelnose sturgeon is pale brown or pale yellowish olive, without blotches or spots. The belly is covered with small, bony, scalelike plates. The snout is broad, flat, and shovel shaped. The body is slender and the tail ends in a long filament. Mature adults spawn in the spring and early summer over rocky substrate in the channels of large rivers in rapidly flowing water.

Pallid Sturgeon: *Scaphirhynchus albus* (Forbes and Richardson)

The pallid sturgeon is primarily restricted to the main channels of the Missouri and the lower half of the Mississippi Rivers and certain of their tributaries. It is usually found in extremely turbid waters in areas of strong current. It is less abundant than the closely related shovelnose and is considered threatened or endangered throughout most of its range. When the shovelnose and pallid sturgeon occur together, the pallid sturgeon population appears as the minority species and in some instances is outnumbered by the shovelnose by a ratio of 40:1. Extensive hybridization often occurs between the two species, a situation that may lead to the extinction of the less abundant pallid sturgeon in some areas.

The pallid sturgeon has coloring similar to that of the shovelnose; it is light brown dorsally and white on the ventral side. It is distinguished from the shovelnose sturgeon by its lack of bony plates on the belly, dorsal fin rays numbering 37 or

more, 24 or more anal fin rays, and the position and length of the barbels.

The diet of the pallid sturgeon consists of aquatic insects and small fish. It is a freshwater species that spawns between June and August in flowing waters. Otherwise, little is known of its life history.

Paddlefish: *Polyodon spathula* (Walbaum)

Paddlefish belong to the same order as sturgeon but are in the family Polyodontidae. There are two living species, *Psephurus gladius* of the Yangtze River in China and *Polyodon spathula* of the United States. The American paddlefish was once common throughout much of the Mississippi Valley and the Gulf slope drainages, from the San Jacinto River in Texas east to the Mobile Bay basin in Alabama. The species was known in Lake Erie before 1903, but its status in the Great Lakes has been uncertain since. Like most sturgeon, the paddlefish has declined in abundance due to habitat loss and overharvest. At present it is found in scattered locations throughout the Mississippi Valley and the Gulf slope drainages, with the only sizable populations in the Osage drainage system in Missouri. The largest populations now are in large, free-flowing rivers rich in zooplankton, its dietary staple, but fish are also found in impounded waters where there are suitable spawning sites.

The most distinctive feature of the paddlefish is its paddle-shaped rostrum that makes up one-third of its total length. The dark, gray-green body is scaleless and lacks the bony plates or scutes characteristic of sturgeon. Paddlefish are found in rivers at depths of 3 meters or more, but in spring and summer are often active near the surface and may be seen leaping out of the water. They have also been observed in saline waters.

Paddlefish feed primarily on plankton, especially copepods, and some insects, algae, and plant fragments. Adults filter the microscopic food through gill rakers while swimming through the water open mouthed. They migrate upstream to spawn as water levels rise in spring and summer. They sometimes spawn in swift water over gravel bottoms or over sand and pebbles at depths of 4.5 to 6 meters, sometimes in schools. In years when stream levels and water temperatures are not suitable for spawning, females reabsorb their eggs and return downstream without spawning.

Status of Sturgeon and Paddlefish Species in the United States

The U.S. Fish and Wildlife Service, in concert with the various states' Departments of Natural Re-

MISSOURI STATE COLLEGE LIBRARY

sources, establishes regulations to protect the integrity of wildlife populations. The regulations govern the commercial and sports harvest of a species or prohibit harvest or disturbance of the population to protect the species. With respect to foodfish species from the natural resource, the ultimate objective is to regulate a sustained harvest of stable populations both in the commercial and sport fishing sectors.

Sturgeon populations in the United States are in decline, and their status as regulated by federal

and state resource agencies in several states is in the process of change. Before working with sturgeon populations, contact the Regional Office of the U.S. Fish and Wildlife Service and the State Resources Agency in your area. Additional information on the status of sturgeon can be obtained from the U.S. Fish and Wildlife Service, Endangered Species Office, Washington, DC. Addresses for regional offices are listed in the front of this manual.

TABLE 1. Summary of selected biological data for the North American Acipenseriformes*

Species	Maximum weight	Maximum length†	Age and size at maturity	Fecundity (eggs/female)	Migratory habits	Spawning of wild populations	Time to hatch under culture
<i>White Sturgeon</i>	816 kg (44)	610 cm FL (32)	Males: 9-22 yr (32,184) Females: 11-34 yr (184) and at least 110 cm (156)	100,000 to 4,700,000 (156)	Semianadromous, anadromous, and landlocked populations. Mature adults move upstream in spring to spawn, return downstream late summer (63,150,170). In lower Columbia River, juveniles move upstream late summer-fall up to 160 km and downstream spring-early summer (183,7). In mid-Columbia River, smaller sturgeon move downstream in summer and larger individuals move upstream summer and fall (96,97). Tagged individuals have traveled up Pacific Coast 1,000 km, but movement at sea not well known (36,121).	California: mid-February-late May at 7.8°-22.2°C (109) Oregon: May-July at 9°-17°C (32) Canada: May and June (183)	7-8 days at 14°-16°C (64)
<i>Atlantic Sturgeon</i>	369 kg (207)	427 cm TL (207)	Males: 5-24 yr (183,187) Females: 7-30 yr (67, 187)	500,000 to 3,760,000 (32,183)	Anadromous. Most growth occurs at sea (183,186,187). Move into freshwater before spawning season, which ranges from February-July (186). Known to migrate up to 1,500 km (183).	Georgia, Florida, South Carolina: February (186,187) Chesapeake Bay: April (186) Delaware River: May at 13.3°-17.8°C (23) Hudson River: late April-May (186) Gulf of Maine: May-June (186) St. Lawrence River: late May-early July (183)	94 hr at 20°C (54) 168 hr at 17.8°C (210) 108-140 hr at 14.5°-22°C (190) 121-140 hr at 16°-19°C (189)

* Numbers in parentheses indicate reference citation.

† TL = total length, from tip of lower jaw or end of snout to tip of longest caudal lobe; SL = standard length, from tip of lower jaw or end of snout to end of vertebral column; FL = fork length, from tip of lower jaw or snout to center of fork of caudal fin.

(continued)

TABLE 1. continued

Species	Maximum weight	Maximum length†	Age and size at maturity	Fecundity (eggs/female)	Migratory habits	Spawning of wild populations	Time to hatch under culture
<i>Lake Sturgeon</i>	140.6 kg (94)	241.3 cm (94)	Males: 12-22 yr (94,176,183) and at least 76 cm (94) Females: 14-33 yr (94,176,183) and at least 84 cm (94)	50,000 to 3,755,745 (49,207)	A freshwater species, sometimes found in brackish water (32,90). In spring as ice melts migrate to smaller rivers to spawn, or sometimes to very shallow areas of lakes (94). Migrate up to 400 km (207). Tagging studies show some males return to same spawning grounds in different years (32). Some also show a homing tendency, returning to "home lake" after spawning (94).	Quebec: begin May-end June at 18.4°C (135,207,210) Ontario: end May-early June at 12°-19°C (32) Lake Champlain: mid-end May (94) Minnesota: last 3 weeks May (94) Wisconsin: mid-April-mid-May at 12°-15°C (32,73) Manitoba: mid-June (94) [optimum water temperature for spawning: 13°-18°C (183)]	80-105 hr at 20°C (212) 380-430 hr at 10°C (212) 5-8 days at 15.6°-17.8°C (94) 4-8 days at 13°-16°C (51) 8 days at 15°-16°C (160)
<i>Short-nose Sturgeon</i>	23.6 kg (52)	143 cm TL (52)	Males: 4-26 yr (88,201,52) and at least 47.5 cm (88) Females: 6-20 yr (88,201,52) and at least 52 cm (52)	27,000 to 208,000 (52)	Anadromous, but not as migratory as other sturgeon (183). Spawn in brackish areas of tidal rivers (89). Spawning population of St. John River, Canada migrates upstream spring-summer, downstream fall, up to 30 km (52). Many ripening females and some males of this population also move upstream in fall and overwinter in freshwater areas next to spawning grounds (52). Cohort migration or pair bonding thought to occur (52). Connecticut River population moves up- and downstream between different parts of river for summer feeding, spawning, and overwintering, in addition to a fall and spring spawning migration (27). Some adults remain in freshwater year-round (27).	Connecticut River: May at 10°-15°C (201) Hudson River: April (88) St. John River, Canada: mid-May-mid-June at 10°-15°C (51) Delaware River: mid-April (146)	8 days at 17°C (26) 12 days at mean of 11.7°C (214) 13 days at 7.8°-12.2°C (146) 111-121 hr at mean of 20°C (188) 136 hr at mean of 18°C (188)
<i>Paddlefish</i>	83.5 kg (72)	216 cm SL (1)	Males: 7 yr (32) and at least 100 cm (32,205) Females: 9-14 yr (32,205) and at least 108-130 cm (32,205)	82,397 to 608,650 (158-172)	A freshwater species, known to spawn in rapidly flowing water over large gravel bars (167). Migrate upstream in early spring as rivers rise 2-3 meters and water temperature reaches 10°C (167, 95). As water levels recede, downstream migration occurs (167,195).	Missouri: April-June at 16.1°C (12,167) Mississippi River from the mouth of the Illinois River to the mouth of the Ohio: end April-begin May (205)	12 days at 12.7°-15°C (168) 10-12 days at 11.1°-14.4°C (177) 7 days at 18.3°-21.2°C (167) 9-10 days at 14°C (12)
<i>Green Sturgeon</i>	159 kg (44)	230 cm FL (156)	Age and size at maturity not reported.	—‡	Anadromous, but migratory habits not well known. Seen at mouths of large rivers August and September (120,183). Appear to move into freshwater during fall-winter for spawning in spring (120,183). Travel up Pacific Coast 1,000 km and spend more time at sea than white sturgeon (36,150).	Spawn in spring (120,183)	—

‡ — indicates data unavailable.

(continued)

TABLE 1. *continued*

Species	Maximum weight	Maximum length†	Age and size at maturity	Fecundity (eggs/female)	Migratory habits	Spawning of wild populations	Time to hatch under culture
<i>Pallid Sturgeon</i>	30.8 kg (32)	168 cm TL (25)	Males: mature 3-4 yr at 53.3-58.4 cm (104) Females: Age and size at maturity for females unknown (104)	—‡	A rare and little known fresh-water species that prefers very turbulent waters and spawns in flowing waters in spring (34) and early summer (122).	Illinois: June and July (122) Missouri: spring (34)	—
<i>Shovel-nose Sturgeon</i>	4.5 kg (32)	85.3 cm FL (123)	Adults mature at 5-7 yr (123) and at least 35.6 cm TL (32)	—	A freshwater species that spawns in channels of large rivers in areas of strong current over rocky substrates (123).	Kansas: April (32) South Dakota: late May-early July (32,155)	—

‡ — indicates data unavailable.

SECTION II

Gamete Biology

Overview

Compared with modern teleost fish, most sturgeon species are longlived and require more time to mature and produce viable sperm and eggs. Anatomical and cytological sexual differentiation occurs unusually late and is not apparent in some species until they are 2 to 9 years of age. There is evidence, however, that the gonadal development depends more on size than age. Some species held in captivity and exhibiting faster growth have matured earlier than fish in the natural environment. White sturgeon males produced from hatchery stock have exhibited sexual maturity at 4 years of age and have been used to fertilize eggs from females caught in the wild.

Females of all sturgeon species spawn several times in their lifetime but never spawn in consecutive years, as it takes longer than 1 year to produce mature eggs. Intervals of 2 to 8 years between spawns are common for some species. In a given spawning run the sexually active population will consist of different age classes, comprise different-size fish, and include only 10 to 20 percent of the total adult sturgeon population of that species in the area. In addition, fecundity varies extensively among species and among individuals in a species.

The techniques for fertilizing sturgeon eggs differ from those used with salmonids because of inherent differences in sperm and egg structure, physiology, and biochemistry. Although considerable information on sturgeon gametes and their development is available, the information is not complete. Because these events influence how eggs and sperm are treated during artificial propagation, an understanding of the current literature is essential to hatchery success. The techniques for egg fertilization are the same for the different species of sturgeon; most of the information on sturgeon gametes is based on the Russian species (the Russian sturgeon, *Acipenser guldenstadti*, the sevruga, *A. stellatus*, and the beluga, *Huso huso*) and on the white sturgeon (*Acipenser transmontanus*). In this section we will review critical elements of gametogenesis, provide information on mature gametes, and describe the process of fertilization.

Gametogenesis

Gametogenesis is the production of mature germ cells and includes oogenesis (egg formation) and

spermatogenesis (sperm formation). Both processes of gametogenesis are obviously of equal importance, but attention has been given to oogenesis because of its greater biological complexity, as well as the far greater difficulties encountered when obtaining viable eggs for hatchery operations. Mature females are difficult to obtain from wild stocks and at this time are even more difficult to raise from hatchery-produced stock. Although no mature eggs have yet been obtained from North American domestic broodstock, production of eggs from hatchery-produced female sturgeon is expected in the near future. More rapid progress has been made in the maturation of hatchery-produced male sturgeon, and milt from these animals has been used to fertilize wild-caught females.

The process of gametogenesis in sturgeon species follows the general pattern of other teleost fish. For our purposes, we will limit discussion here to a summary overview of specific events in gametogenesis that will facilitate a better understanding of subsequent sections on broodstock capture, broodstock examination, spawning induction, and egg fertilization. More detailed descriptions may be obtained from the section references.

Oogenesis

As female sturgeon mature, profound changes occur in their ovaries, including the formation of germ cells that ultimately become mature oocytes. These cells start as small oogonia (less than 0.15 mm in diameter) that proliferate along the borders of the ovarian folds consisting of germinal epithelium and adipose or fatty tissue. At the onset of meiosis, the oogonia become primary oocytes, which undergo two periods of growth, the first associated with an increase in cytoplasm volume (previtellogenesis) and the second with deposition of yolk platelets (vitellogenesis). As vitellogenesis continues, the oocyte enlarges to an approximate 3.8 mm, final size prematuration stage. The previtellogenic growth phase takes 2 or more years, whereas vitellogenesis occurs within 1 or 2 years and requires a synthesis of yolk precursor secreted by liver cells. During this period, the gonadosomatic index, or relationship between gonad weight and somatic tissue, increases dramatically, to 20 or 30 percent in some species. The changes in the developing oocyte from the completion of vitellogenesis to spawning have been

studied extensively in the Russian species of sturgeon and are described in detail by Detlaf et al. (1981). The following description is based primarily on those descriptions and is applicable to North American species.

During spawning migrations female sturgeon enter the river systems carrying late-stage vitellogenic oocytes. Females that will spawn migrate toward the spawning ground, and their oocytes continue to mature. Their ovaries contain vitellogenic, darkly pigmented oocytes, and small, unpigmented oocytes that are in the previtellogenic phase. The small, underdeveloped oocytes will remain in a previtellogenic stage until after the older, larger vitellogenic oocytes are spawned. They will become the next generation of oocytes to be spawned in a later migration.

Each vitellogenic oocyte plus its follicular envelope is called a follicle. The follicular envelope consists of two layers, the follicular (granulosa) layer immediately adjacent to the surface of the eggs and a fibrous layer, called the theca, which contains blood vessels. The follicles on the side of the ovary that faces the coelom are covered by a thin layer of epithelium. Those on the opposite side are adjacent to the ovarian wall (fig. 1). Female sturgeon are gymnoovarian, meaning the eggs are not membrane-bound but proliferate from the ovary into the coelomic cavity and are covered by a simple epithelial layer.

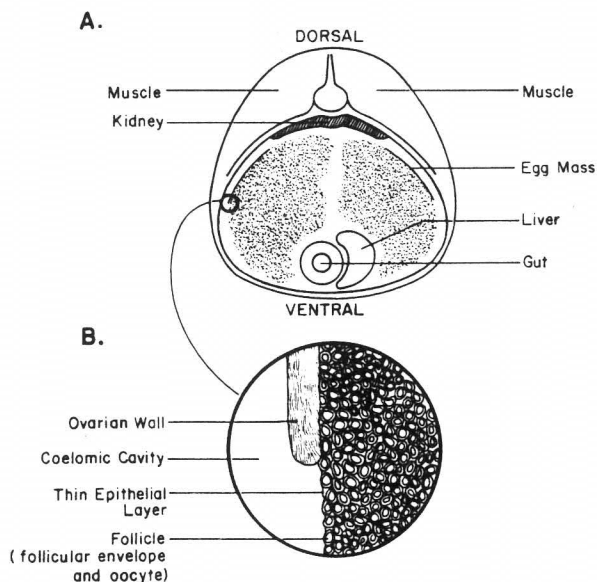

Fig. 1. Diagram of (a) cross-section 10-18 cm behind the pectoral fin of a female sturgeon showing position of gonad in the body cavity and (b) detail showing oocytes in relation to the ovarian wall and coelomic cavity.

At the completion of vitellogenesis, the oocytes are considered ripe, but additional development is necessary before they are capable of being fertilized. The ripe oocyte, covered by a follicular envelope, undergoes polarization. In this process the oocyte differentiates into a vegetal hemisphere filled with large granules of yolk and large oil droplets and an animal hemisphere containing a large mass of cytoplasm with smaller granules of yolk and small spheres of oil. Immediately beneath the oocyte surface is a layer of small vesicles called cortical granules, and the pigment granule layer.

The nucleus of the polarized oocyte is larger than that of a typical somatic cell. It contains four sets of chromosomes ($4n$), and is called a germinal vesicle (GV). Reduction of the egg genomic content occurs only during ovulation (to $2n$) and postfertilization (to n). As the polarization progresses, the GV migrates from its central position into the animal hemisphere. Oocyte development is considered complete, and the oocyte in a preovulatory condition when the GV has migrated to the animal pole and is positioned in the cortical ooplasm of the animal hemisphere. These events have been used to judge the maturity of oocytes that are removed from a female broodfish. In this state the GV is surrounded by small, finely granulated yolk in the animal hemisphere, and the yolk granules and oil droplets in the vegetal hemisphere have achieved their maximum size. In addition to the two follicular layers, the oocyte has its own envelope, the zona radiata, consisting of an interior, exterior, and gelatinous layer. Precursors of future channels (micropyles) through the three layers to the surface of the egg are forming at this time. The micropyles, formed by specialized follicular cells, penetrate the oocyte envelope at the animal pole. When these events are completed, the oocyte is considered capable of responding to the hormonal stimuli necessary for ovulation and fertilization.

After polarization is completed and immediately prior to spawning, the follicles undergo a process called final egg maturation. This process is preceded by a massive release of gonadotropin hormone from the sturgeon's pituitary gland and an increase in concentration of this hormone in the peripheral blood plasma (the ovarian surge of gonadotropin). Circulating gonadotropin stimulates a secretion of the maturation-inducing steroid hormone by the two-layered follicular envelope. This hormone binds to the egg receptors and stimulates the final maturation events leading to germinal vesicle breakdown (GVBD), which is the breakdown of the nuclear membrane and release of the nuclear contents into the cytoplasm of the animal pole. Vacuoles form between the follicular cells and the gelatinous layer of the oocyte.

The number of vacuoles increases until the follicular layer eventually separates from the surface of the oocyte. Ovulation is the breakdown of the follicular envelope surrounding the individual oocyte and release of the oocyte into the coelomic cavity (fig. 2). Once ovulation is completed, the eggs are free in the coelomic cavity. Possibly the intimate connection between the follicular layer and the egg envelope is now removed by proteolytic enzymes produced by granulosa cells. During the act of spawning (oviposition) they are passed through the sturgeon's oviduct by the muscular contraction of the abdomen (see Appendix 4 for description of oviduct structure). Ovulated sturgeon eggs are in metaphase of the second meiotic division. The meiotic process is arrested and the expulsion of the second polar body does not occur until the eggs leave the female and are fertilized.

The processes of oocyte maturation and ovulation are, in essence, preprogrammed. Once triggered by the gonadotropin and maturation inducing steroid, the process runs to completion with no other external hormone input (hormone-independent phase). Individual follicles that are surgically removed from the ovary after entering the hormone-independent phase and placed in a suitable hormone-free, artificial environment, proceed to full development. The follicles mature, ovulate, and produce viable fry when fertilized. In addition, the process of ovulation in sturgeon that have undergone spawning induction is apparently not

synchronous: ovulation is thought not to occur in all preovulatory oocytes at the same time but to progress in a wave from the posterior to the anterior end of the ovary over a period of several hours. Application of these concepts is considered important to hatchery success because the impact of artificial induction on these and other associated physiologic processes affects how and when the ova should be removed from the fish.

In nature all these processes are regulated by the endocrine system and synchronized by the spawning behavior of both sexes. In the hatchery, ovulation is induced by the administration of exogenous gonadotropins or gonadotropin-releasing hormones, while the female is kept separate from the male to prevent spontaneous spawning and problems associated with adhesion of fertilized eggs. Thus, ovulation may occur in a more compressed period of time, and oviposition will be greatly reduced or may not occur at all. It is detrimental for eggs to remain in the coelomic cavity for extended periods because, once ovulated, the ova are deprived of blood and oxygen supplies. If they remain in this condition too long, they will become overripe and thus unsuitable for fertilization. This condition is thought to be reached within 2 to 3 hours postovulation, depending on the size of the female. In addition, during this same time period many of the oocytes are still in a preovulatory state. The oocytes will proceed through ovulation but in some cases not for many hours.

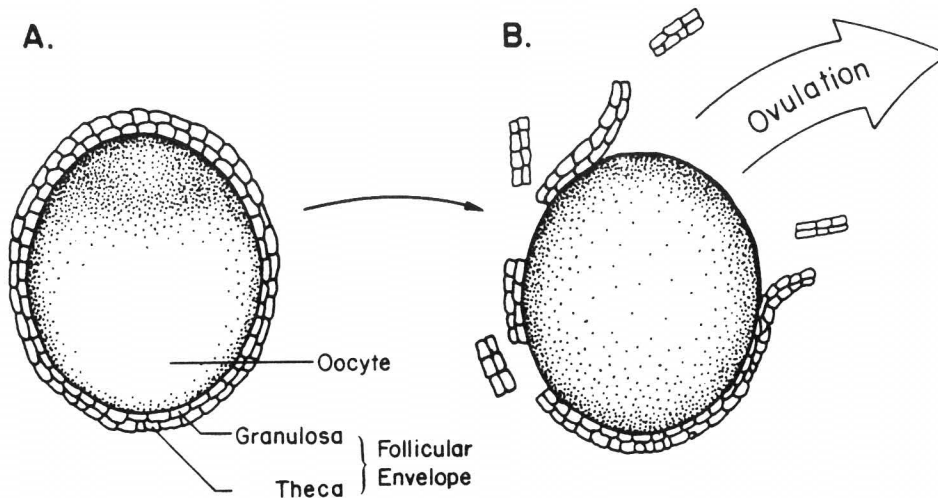

Fig. 2. Diagrams of the sturgeon oocyte in cross-section showing (a) the preovulatory oocyte with follicular envelope and (b) the disassociation of the follicular envelope and the release of the oocyte into the coelomic cavity.

Recognition of the oocytes' ability to ovulate during the hormone-independent phase and that ovulation is nonsynchronous is considered critical to the process of artificial propagation. Although the inertia of the hormone-independent phase has begun and will eventually lead to ovulation of all oocytes, the process is not synchronous for the total spawn. To avoid having the early-ovulate oocytes become overripe as a result of staggered ovulation and suppression of oviposition, hatchery personnel must manually remove the eggs at the optimal time. At this point, the process is more art than science.

To obtain the best possible fertilization success, the ova are manually removed when hatchery personnel judge that approximately half of the ova have ovulated and the remaining half are in the ovary receiving oxygen, but in the inertia phase of development. The ovulated ova in the coelomic cavity are removed, then the preovulatory oocytes are gently scraped from the ovary. Because of the inertia of development, these ova will undergo ovulation in the fertilization bowls before the milt is added during the fertilization process. By this technique, fertilization success is improved, as ova are taken from both portions of the developing spawn, and at the proper time

Mature Gametes and Fertilization

The mature ovum of white sturgeon is heavily pigmented and approximately 3.7 to 4.0 mm in diameter. Researchers in the United States describe the white sturgeon egg envelope, or chorion, as a 50.0- μm thick structure that consists of four distinct layers (fig. 3). The outermost layer, J, is called the jelly layer. It surrounds the egg and extends into the ducts of the next layer, L3, which is anchored to the layer beneath, L2, by unusual acellular helical structures originating from L2, which are referred to as bioscrews (fig. 4). The innermost layer, L1, immediately surrounds the egg plasma membrane, or oolemma. Both L2 and L1 are composed of fibrils with filamentous substructural elements; they are comparable to the chorions of other fish eggs due to their structure and tough protective properties.

Russian literature describes sturgeon eggs as having three distinct layers, L1 zona radiata internal; L2 zona radiata external; L3 gelatinous; and L4 the adhesive coat that is not secreted until the egg undergoes water activation. They do not consider L4 to be part of the egg envelope.

Acipenserid eggs also differ from other fish eggs in that they possess numerous micropyles located within a 200- μm area at the animal pole (fig. 5a). The number of micropyles per egg in white sturgeon ranges from 3 to 15, with an

average of seven. In general, each micropyle is funnel shaped, tapering to a diameter of 1.5 μm , or about the diameter of a single sturgeon sperm (fig. 5b). These micropyles extend through the outer four layers and provide the sperm direct access to the egg's oolemma.

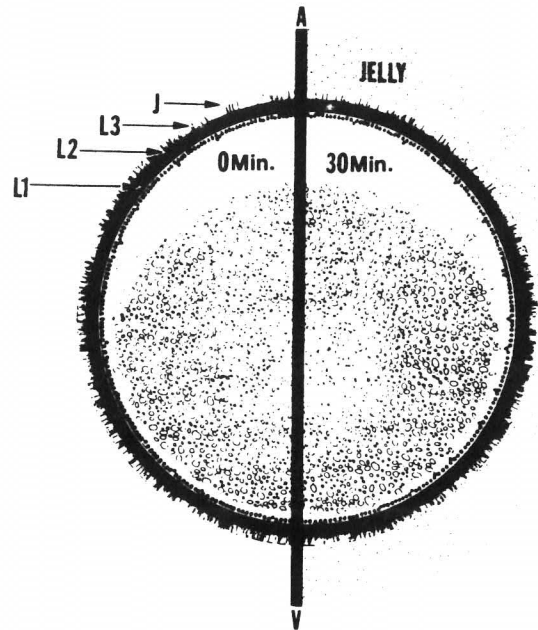

Fig. 3. Schematic representation of white sturgeon egg before (0 min.) and after (30 min.) freshwater exposure, showing the four layers of the egg envelope: J (jelly layer), L3 (layer containing ducts, or micropyles), L2 (layer containing bioscrews that anchor L3), and L1 (layer immediately surrounding the oolemma). A, animal pole; V, vegetal pole. (Cherr et al., 1985. Reprinted with permission of Dr. W. Junk Publishers.)

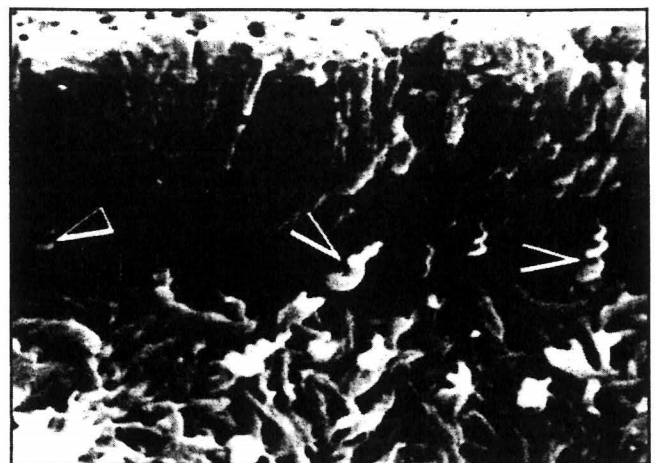

Fig. 4. Scanning electron micrograph of white sturgeon egg demonstrating the bioscrews (arrows) of L2 that anchor L3 and the jelly to the egg. 2500X. (Cherr et al., 1985. Reprinted with permission of Dr. W. Junk Publishers.)

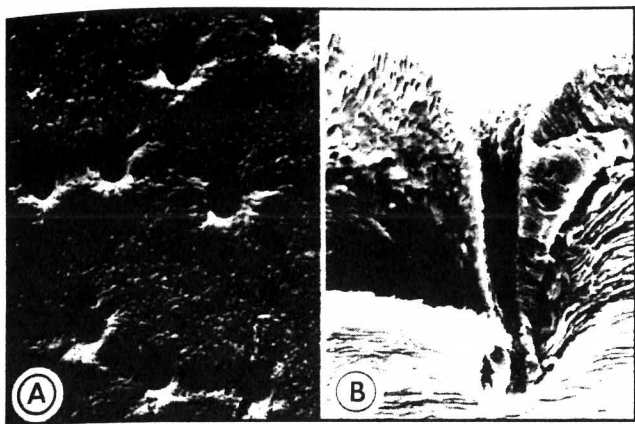

Fig. 5. Scanning electron micrographs of white sturgeon egg. (a) Egg surface with jelly removed, showing micropyles at the animal poles. 500X. (b) Fracture through a micropyle down to L1, showing micropyle extension to the oolemma. 1800X. (Cherr et al., 1985. Reprinted with permission of Dr. W. Junk Publishers.)

The adhesive jelly layer in sturgeon eggs remains throughout early development. In natural spawning the adhesiveness of the jelly is important for anchoring the egg to the substrate in moving water. Adhesivity is strongest at the vegetal pole and may serve to attach the egg to the substrate at that pole. Such an attachment would orient the micropyles upward before fertilization. When sturgeon eggs are immersed in freshwater (river water, distilled water, or freshwater with a defined composition), the jelly layer is released from the surface and the ducts of L3. The jelly hydrates within five minutes and becomes adhesive. This adhesiveness is independent of fertilization.

The bioscrews originating from L2 may function as an anchoring mechanism for the adhesive jelly layer. They retain their association with L3 following fertilization, cleavage, and early development and may help anchor the jelly layer, since this layer resides external to L3.

Sturgeon sperm has been examined and described. Sturgeon sperm differ from salmonid sperm in a number of ways, including morphology (fig. 6) and longer duration of motility in freshwater. A major morphologic difference is the presence of acrosomes in the sturgeon sperm. Unlike trout sperm, white sturgeon sperm are not motile in the coelomic fluid of the female. When diluted in water, the sperm immediately become active or motile. The percentage of motile sperm decreases within three minutes, and by five minutes postdilution most sturgeon sperm cease all directed motility.

Sturgeon are broadcast spawners, and in nature the eggs are spawned into fast-moving water where they are dispersed over a large area

of the river bottom. In broadcast spawning the sperm concentration is lower in the surrounding medium than for fish that spawn in nests. The presence of numerous micropyles in the eggs may aid successful fertilization at these low concentrations of sperm.

Another hypothesis for the presence of numerous micropyles is to provide a location for the sturgeon sperm acrosome reaction to occur out of the external water medium, which might dilute the soluble inducer of the reaction. The presence of numerous micropyles does not appear to increase the chances of polyspermy, although numerous sperm may be seen in the micropyle area (fig. 7).

When applying this information to hatchery operations, note that timing is critical in the fertilization of sturgeon eggs. All protocols and equipment necessary to complete the steps leading to incubation of the eggs must be understood and prepared in advance. Just as important changes in the sperm are initiated by water contact, the eggs also undergo water-induced changes that are fairly rapid and irreversible. The hydration of the egg's

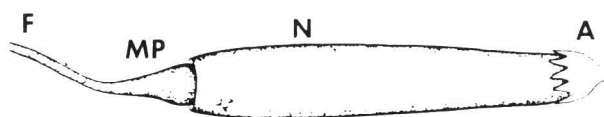

Fig. 6. Schematic diagram of white sturgeon spermatozoa. A, acrosome; N, nucleus; MP, midpiece; F, flagellum. (Cherr et al., 1985. Reprinted with permission of Dr. W. Junk Publishers.)

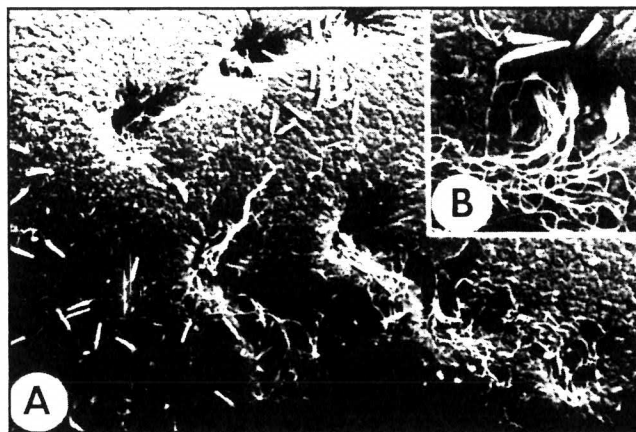

Fig. 7. Scanning electron micrograph of a white sturgeon egg one minute after insemination with white sturgeon sperm (10^3 sperm/egg). (a) Surface scan with jelly layer removed, showing micropyles and numerous sperm. 500X. (b) Higher magnification of a single micropyle with numerous sperm. 2500X. (Cherr et al., 1985. Reprinted with permission of Dr. W. Junk Publishers.)

jelly layer and the resultant stickiness of the eggs is a useful adaptation in nature, but if not controlled in the hatchery, this reaction will result in loss of the spawn. The eggs will stick to virtually any surface, whether wet or dry, and even to each other. If the stickiness is not countered before the eggs are placed in the incubators, they will form a mass that will quickly suffocate or die from fungal disease.

Sturgeon sperm must be collected with no water contact. In nature, fertilization is accom-

plished after sperm, egg, and water are in simultaneous contact. In the hatchery, however, these events must be separated. Once the sperm is water-activated, fertilization must occur before the sperm depletes its energy reserves. For sturgeon sperm the period of activation after contact with water is about two to five minutes. If the sperm is collected in its seminal fluid (dry state) without contact with water, the individual sperm remain quiescent and may be stored for future use (for milt storage procedure, see Section VIII).

SECTION III

Embryology and Larval Development

Overview

Sturgeon embryology, including cleavage, gastrulation, and early embryogenesis, is similar to that of anuran amphibian eggs. Most knowledge of sturgeon embryology is based on studies of two Russian sturgeon, the sevruga and beluga sturgeon, and the white, lake, and Atlantic sturgeon of North America. The sturgeon embryology described below is based on the work of Beer (1981) and Wang (1984). Beer worked with the white sturgeon and Wang with both the white and lake sturgeon. Wang observed that white and lake sturgeon have identical cleavage patterns and that morphologic differences first become apparent at the larval stages. These studies were fairly comprehensive, and the embryology outlined is similar to that described for other North American species of sturgeon. References to embryologic studies of other sturgeon species are found with the references cited for this section.

The rate of embryonic and larval development of sturgeon is influenced by temperature. Higher incubation temperatures reduce the time required for development, but each species has slightly different tolerances and an optimal temperature range that results in higher survival. The optimal temperature range reported for white, lake, and Atlantic sturgeon is 14° to 17°C.

The developmental sequence presented below is based on observations at variable water temperatures. Beer's posthatching data were taken from fish initially raised at 20°C with temperatures adjusted downward as hatchery water conditions mandated (range 16° to 20°C). Although the time frames of the developmental events described will differ from those of fish raised at different temperatures, the sequence of events will be the same. Wang had access to water maintained at a more stable temperature and presents a time frame for developmental events that occurred in a water temperature of 15°C (table 2). The descriptions given for the embryologic and larval stages are useful for hatchery work and for comparison, should abnormal development occur.

The most critical period of development is during the initial cleavage stages, within 6 to 10 hours postfertilization. Cleavage lines should be regular and symmetrical, with micromeres appearing in the animal hemisphere followed by macromeres appearing in the yolky vegetal hemisphere. The end of gastrulation and the beginning

of neurulation are also critical developmental events.

TABLE 2. Rate of embryonic development for white and lake sturgeon at 15°C incubation temperature*

Species	Hours/Developmental Events†				
	CLVG	GSTR	NEUR	S-HRT	START HATCH
White	6-9	28.63	65.0	89.5	155.9
Lake	—-‡	37.0	77.7	118.0	208.0
		END HATCH	PY-SPH	Y-DPL	
White		193.1	370.8	546.0	
Lake		250.7	250.0	—-‡	

* Modified from Wang (1984).

† CLVG = First Cleavage

GSTR = Gastrulation

NEUR = Neurulation

S-HRT = S-Heart Stage

‡ Data Unavailable.

START HATCH = Hatching Begins

END HATCH = Hatching Ends

PY-SPH = Pyloric Sphincter

Y-DPL = Yolk Depletion

Sturgeon Embryology

White Sturgeon, *A. transmontanus*

Unfertilized Egg

The unfertilized egg is ovoid, with a long-to-short axis dimension of approximately 3.6 mm × 3.3 mm. Most eggs are slate gray, except for the animal pole, which is usually white. Color variations do exist; some eggs are entirely gray, and others have white splotches over portions of the animal pole, usually a sign of overripeness. Variations are believed to be caused by differences in maturity and condition, but there is not enough information at this time to use color as an indicator of health.

Fertilized Egg

Fertilization brings about an obvious change in pigmentation. The animal pole is light except for a dark spot at the apex. The vegetal pole remains darkly pigmented. The egg membranes have swollen and become adhesive, and expansion of the jelly coat has increased the egg diameter (approximate long axis, 4.0 mm; short axis, 3.8 mm).

Early Cleavage

The first cleavage bisects the animal pole, forming two blastomeres of equal area. The vegetal pole proper remains darkly pigmented, with a light ring (or crescent) around the upper portion of the egg. The second cleavage furrow forms before the first is completed, is perpendicular to the first, and

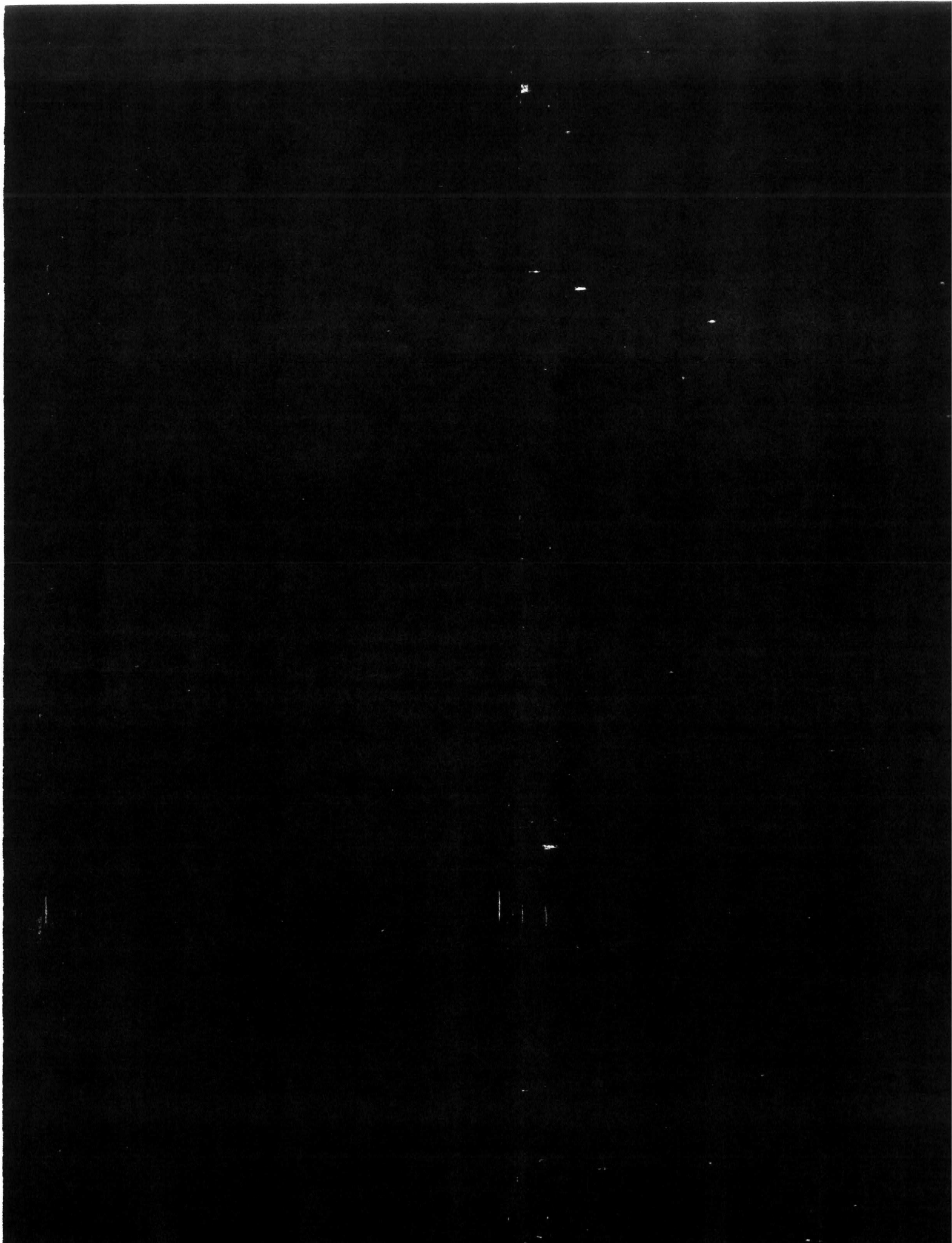

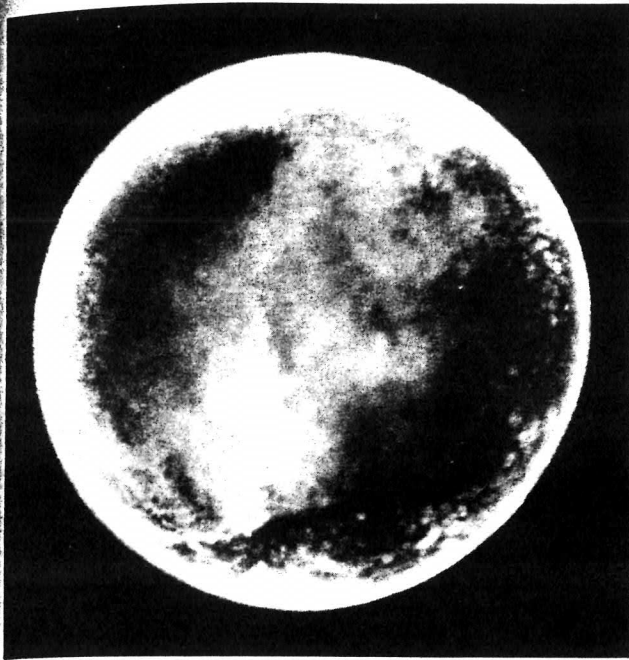

Fig. 10. White sturgeon embryo, advanced cleavage, with numerous micromeres in animal hemisphere and larger macromeres in the vegetal hemisphere. (Beer 1981)



Fig. 12. White sturgeon embryo, showing the future dorsal lip as a narrow pigmented line. (Beer 1981)

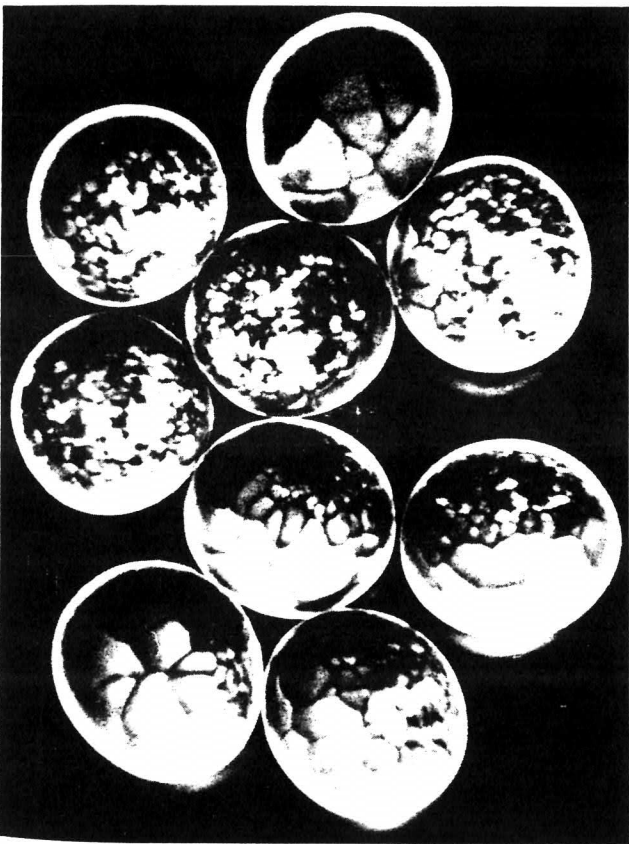

Fig. 11. White sturgeon embryos, various stages of late cleavage. (Beer 1981)

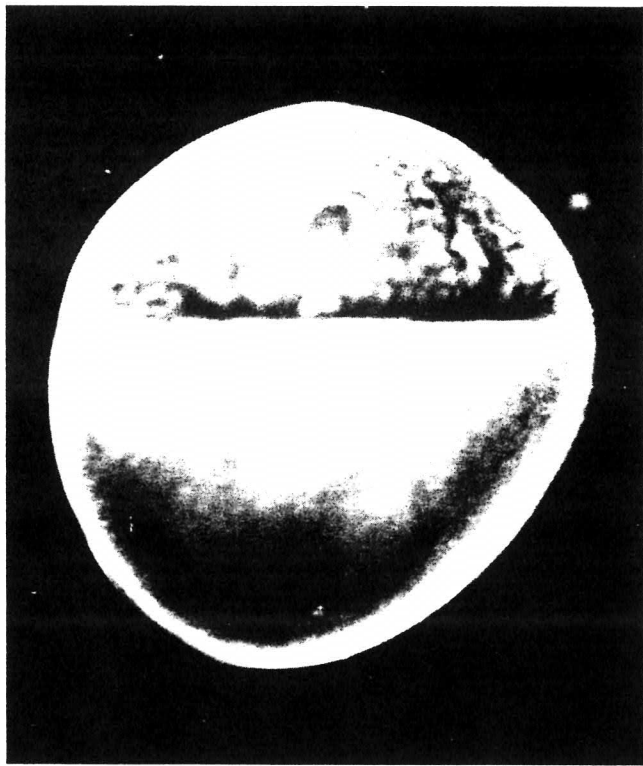

Fig. 13. White sturgeon embryo, early gastrulation, showing involution of cells that will result in the formation of the gastrocoele. (Beer 1981)

hemisphere, in the form of a ring, represents the lip of the blastopore. As epiboly continues, the advancing lip of the blastopore (ring) gradually converges, thereby reducing the size of the ring and the area of the exposed yolk plug. The yolk plug appears dark against the lighter animal region.

As gastrulation proceeds, the center of gravity shifts and rotates the mass 90°. This rotation orients the developing embryo dorsal side up and positions the small yolk plug on the side. The yolk plug shrinks further and becomes elongated as the sides rapidly converge. The first indications of the forming embryo are a thin stria radiating out from the dorsal side of the yolk plug that indicates the embryonic axis and the fine lines of pigmentation that faintly outline the developing embryo (figs. 15 and 16).

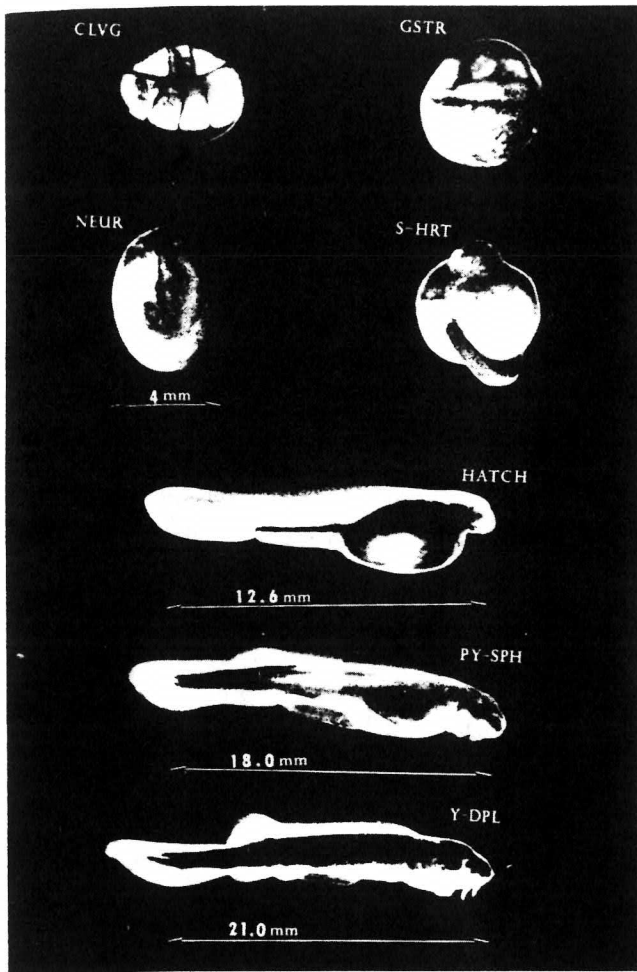

Fig. 14. White sturgeon embryology. (Wang 1984)

CLVG = Early cleavage GSTR = Gastrulation
 NEUR = Neurulation S-HRT = Formation of the heart
 HATCH = Recently hatched sturgeon
 PY-SPH = Formation of the pyloric sphincter
 Y-DPL = Stage of yolk depletion

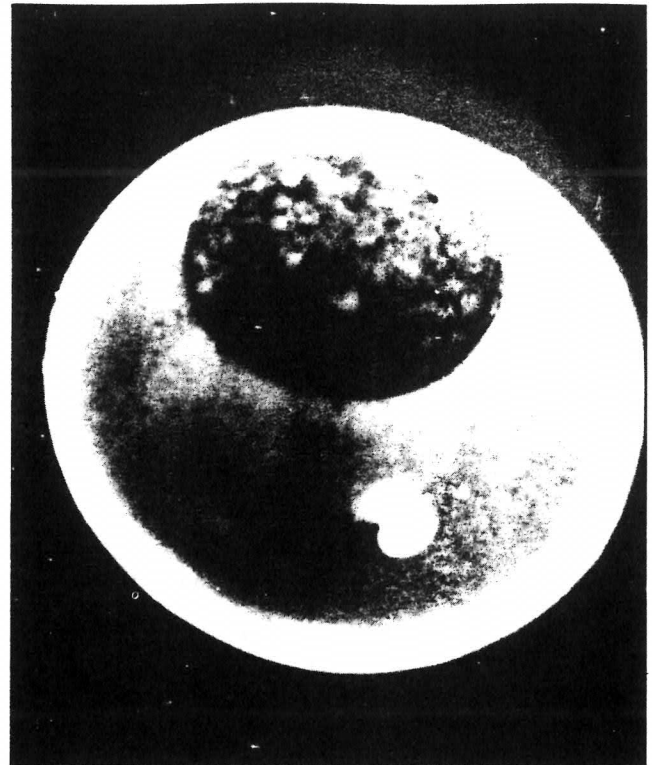

Fig. 15. White sturgeon embryo, yolk plug formation. (Beer 1981)

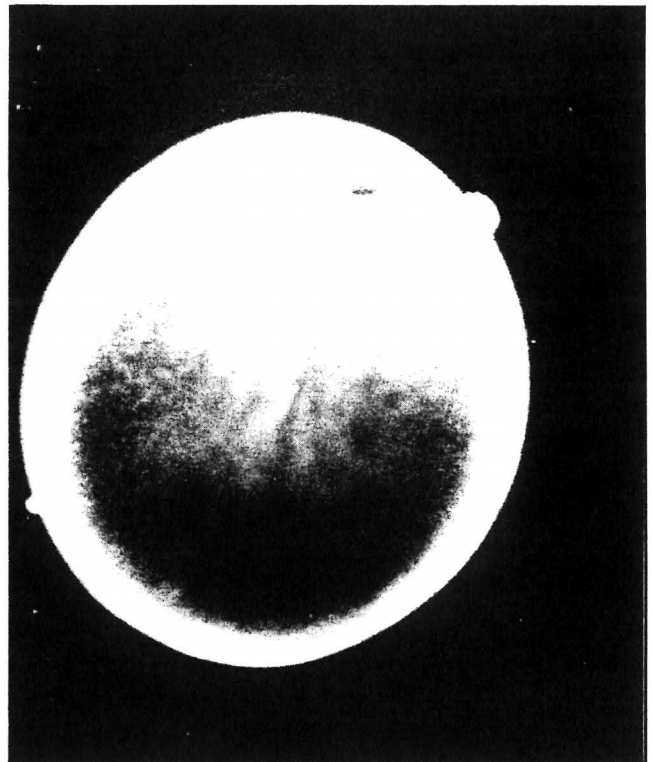

Fig. 16. White sturgeon embryo, late yolk plug stage, with indication of the embryonic axis. (Beer 1981)

Neurulation

Neurulation begins when the lateral lips of the blastopore converge and, simultaneously, the yolk plug disappears in a depression. The neural groove begins as a raised, pigmented plate extending from the blastopore 120° around the mass. During early neurulation the neural groove is broad at its anterior end, forming the cephalic portion of the embryo. As development continues, the cephalic portion forms a diamond-shaped depression, and the embryonic trunk develops around and along the furrow (figs. 14 and 17).

In relief, the trunk and tail rise and become more pronounced. The margins of the furrow begin to extend, fold over, and form a neural tube. Closure of the neurenteric canal, which marks the onset of neural tube formation, occurs first in the midregions, then in the caudal and cephalic regions. As development continues, the cephalic region elongates and forms the three vesicles of the primordial brain. Lateral somites can be seen along the trunk. The general shape of the embryo is wide at the caudal region, tapered at midtrunk, and wide at the foretrunk, indicating the rudiments of the pronephros. The embryo now extends 160° around the yolk sac (figs. 18 and 19).

Elongation of the Pronephros

As the trunk of the embryo narrows, the pronephros expands from the trunk and extends forward in a wing-shaped manner. The anterior cephalic region becomes regionalized and rudimentary eyes are visible. Somites are obvious along the length of the trunk, and the tip of the caudal region is undercut. At this stage the embryo protrudes well above the yolk sac surface and encircles the yolk sac 200° to 300° (fig. 20).

Heart Formation

The heart first appears as a straight tube below the head region of the embryo. The heart tube gradually flexes until it becomes "S" shaped. At this stage each eye appears faintly below the skin epithelium as a light ring surrounding a darkly pigmented center. Olfactory pits and auditory vesicles are apparent. The tail is considerably undercut, is dorsoventrally flattened, and has a continuous fin fold. The embryo encircles the yolk sac 320° to 350° (fig. 14).

Prehatch

Just before hatch, the tip of the tail extends past the head and twists 90° so that the dorsoventrally flattened side lies flush to the egg surface. The intestine appears as a pigmented tube that extends from the posterior edge of the yolk sac to the cloaca, where there is a break in the otherwise continuous fin fold. The fin folds have enlarged and



Fig. 17. White sturgeon embryo, early neurulation showing the neural groove. (Beer 1981)



Fig. 18. White sturgeon embryo, neural tube formation. (Beer 1981)

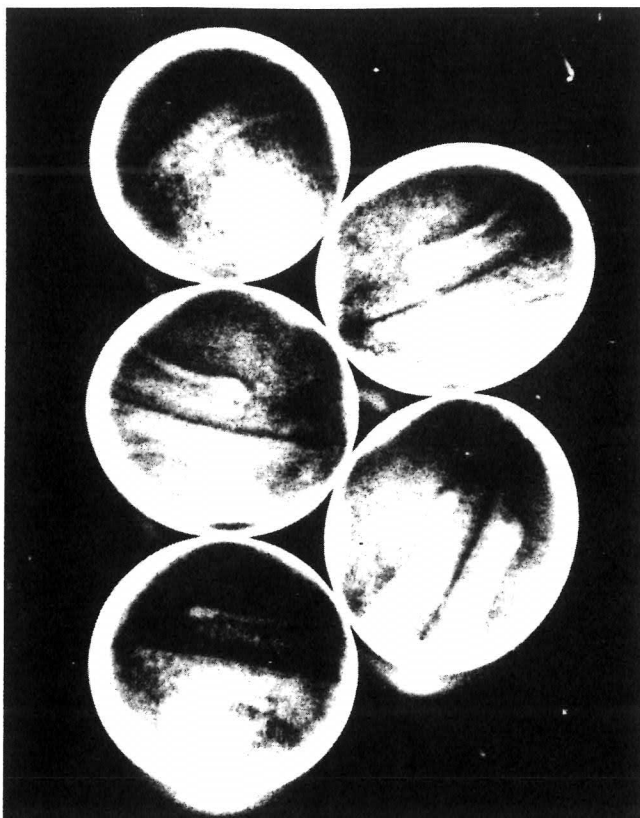

Fig. 19. White sturgeon embryos, various stages of neurulation showing body definition. (Beer 1981)



Fig. 20. White sturgeon embryo, elongation of the pronephros and protrusion of the embryonic body above the yolk sac surface. (Beer 1981)

extend dorsally from the trunk near the pronephros, around the tail, and ventrally to the edge of the yolk sac. The nares, lightly pigmented eyes, auditory vesicles are visible. Just before hatching a reddish, cloudy substance forms between the yolk membrane and the embryo (figs. 21 and 22).

Mass Hatching

Hatching occurs as the larvae break free of the yolk membranes, usually tail first. When free of the membranes, the body trunk extends straight ahead and the tip of the tail is slightly raised. Fifty-five to sixty somites are apparent along the trunk from behind the head to the caudal peduncle. The yolk is orange and granular. The heart can be seen pumping red blood cells through the paired Cuvier's ducts, a circulatory network on the ventral surface of the yolk. Nare pits are evident, and each eye can be distinguished by a small, distinct pigment spot (figs. 23 and 24).

Larval Development at a Variable Temperature Range of 16° to 20°C (Beer 1981)

One Day Posthatch

The pectoral fin bud and the spiral shape of the darkly pigmented intestine are apparent. The gill folds are wider, especially in the caudal region. Rudimentary opercula and eyes are apparent.

Two Days Posthatch

The fin fold that protrudes from the posterior, ventral surface of the yolk forms a well-defined fin bud and the site of the future dorsal fin is pigmented. The operculum flares out from the head, the mouth is open, and four barbel buds are apparent. The midgut is visible as a yellow structure at the ventral, posterior portion of the yolk, and the white liver is seen posterior to the heart. The Cuvier's duct runs dorsoventrally from the heart to the anterior, dorsal surface of the yolk, where it extends prominently. Larvae swim vigorously in a vertical position, often sinking to the tank bottom and then ascending rapidly to the surface. Larvae react to changes in illumination but do not show a prolonged photophobic reaction. Larvae measure about 13.0 to 14.0 mm long (figs. 14 and 25).

Three Days Posthatch

The notochord can be seen slanting up at the head. The open mouth reveals mouth parts, and the gill arches are well defined. Gill filaments with circulating blood can be seen on the branchial arches behind the transparent opercula. The circulatory network on the yolk sac and midgut is well developed. The yellow midgut and white liver are readily visible.

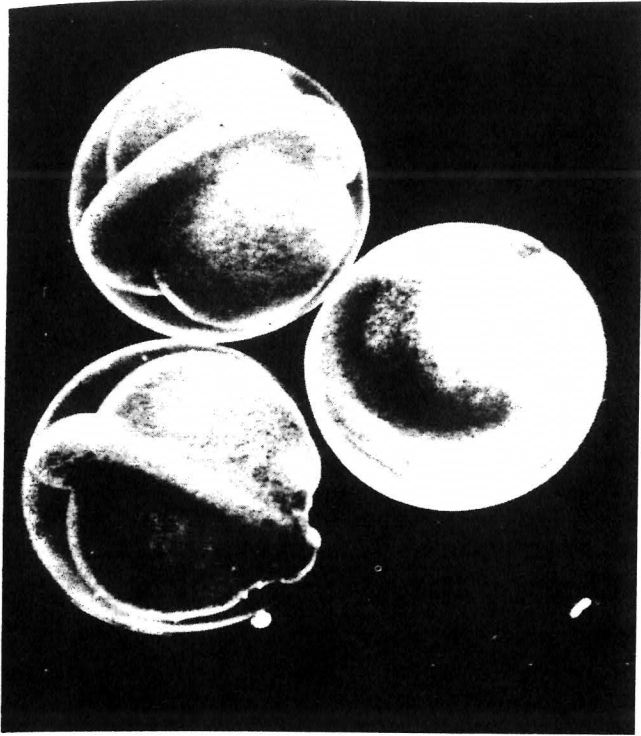

Fig. 21. White sturgeon embryos just before hatch, showing differentiated embryos enclosed in egg membranes. (Beer 1981)

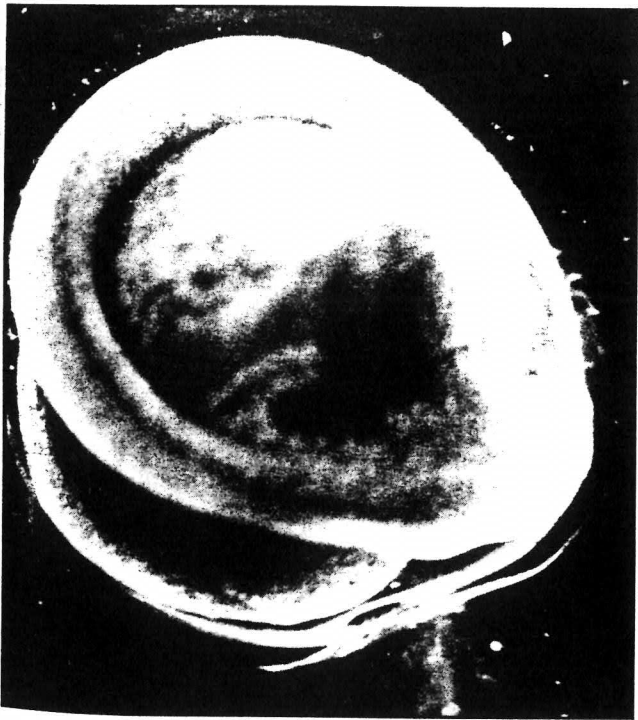

Fig. 22. White sturgeon embryo just before hatch, showing the tail extending past the head and lying against the yolk surface. (Beer 1981)

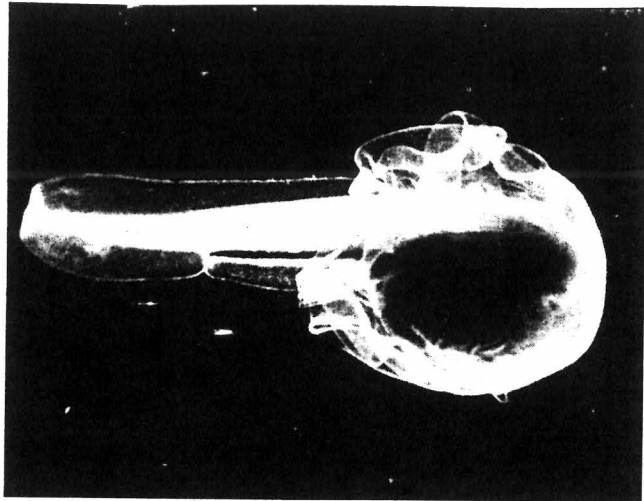

Fig. 23. White sturgeon hatching from the egg tail first. (Beer 1981)

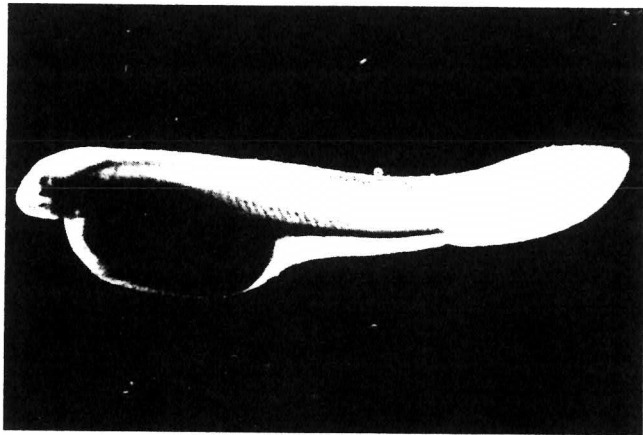

Fig. 24. Newly emerged white sturgeon. (Beer 1981)

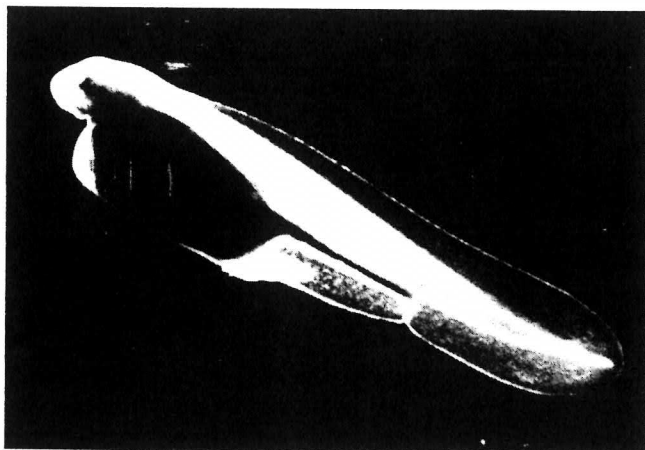

Fig. 25. White sturgeon, 2 days posthatch. (Beer 1981)

and a melanin plug is evident in the posterior portion of the intestine. Melanophores are scattered throughout the body, but are concentrated from the region of the future dorsal fin to the caudal peduncle and on the head and snout. The lateral line extends from behind the head along part of the trunk. Larvae measure about 14.5 mm long.

Four Days Posthatch

Pigmentation increases overall but most particularly along the trunk, posterior to the dorsal fin, and on the head. The tip of the tail is not pigmented. The barbels, eyes, mouth, and pectoral fins are clearly evident. The fin fold narrows at the caudal peduncle and protrudes slightly at the future dorsal, anal, and caudal fins. The fin fold is wider on the ventral side of the notochord, suggesting its heterocercal structure. Pelvic buds are evident anterior to the anal slit in the fin fold, and the lateral line extends the length of the trunk. Gill filaments extend beyond the operculum. Larvae now show an obvious photophobic reaction, clustering together in the darkest, shaded portions of the tank when illuminated. As light intensity decreases, the larvae swim horizontally back up into the water column. The larvae are about 16.0 mm long.

Five Days Posthatch

The pelvic fins are prominent, and the fin fold has narrowed, except at the sites of the dorsal, anal, and caudal fins. The barbels, gills, and pectoral fins have all elongated. Pigmentation is darker on the head, rostrum, and post-dorsal fin portion of the trunk. The lens of the eye is now transparent and is surrounded by the darkly pigmented optic cup. The nares appear as ovoid pits, each with two external openings. The spiral valve intestine is clearly evident because of its darkly pigmented melanin plug. Yellow fluid is seen accumulating within the midgut.

Seven Days Posthatch

The larvae are very dark. The pectoral fin rays are visible at the fin base and extend into the fin fold at the site of the future dorsal fin. The ventral surface of the darkly pigmented yolk is covered by the enlarging gut, which is easily distinguished by its sharp relief and the yellowish fluid it contains. The circulatory network on the yolk has decreased in size and intensity. The gill filaments still extend beyond the operculum, and the barbels and mouth have enlarged. Primordial teeth are evident on the inner jaws. The larvae measure about 17.0 mm long.

Differentiation of the Pyloric Sphincter (Wang 1984)

The sturgeon larval yolk sac is composed of yolk endoderm and later forms the gastrointestinal tract. The posterior, intestinal portion of the yolk sac is depleted first. As the intestinal region shrinks, the color changes from grayish to white, and yellow oil droplets become visible. A narrow connection between the gastric and intestinal regions appears, and a primordial pyloric sphincter clearly divides the gut into two regions. At the formation of the sphincter, the intestine is void of the grayish yolk material, but a yellow oil droplet is apparent.

At this point, the major portion of the yolk sac remains in the future stomach region. The yolk material gradually disappears and can no longer be seen by external observation. External feeding normally begins at this stage (fig. 14).

10 Days Posthatch

The yolk sac protrudes from the body only slightly. Anal fin rays are evident, and the fin fold is discontinuous at the caudal peduncle. The dorsal and pelvic fin rays extend into the fin fold. The barbels are longer, and sensory glands appear on the skin surface on the ventral side of the rostrum. The head, and especially the rostrum, has elongated and has many horny processes apparent on its surface. The gill filaments still extend past the operculum. External feeding has begun. Larvae still show a photophobic reaction to strong light, but they no longer cluster together when the tank is illuminated. Larvae orient to the tank's surface and tend to avoid the open water column. The larvae measure about 23.0 mm long (fig. 26).

13 Days Posthatch

The entire body is darkly pigmented and the yolk has been absorbed. Rays extend into the anal fin, and pigmentation indicates where future rays will appear along the dorsal fin fold. The pectoral fin has migrated to the ventral region of the trunk. Numerous processes are on the top of the head. A faint row of projections, the primordial scutes, are seen parallel and dorsal to the lateral lines along the trunk (fig. 14).

18 Days Posthatch

On the ventral side the fin folds are greatly reduced. Ten rays project into the dorsal fin fold, which is continuous with the dorsal fin. The gills are covered by the operculum. The larvae measure about 25.0 to 26.0 mm long (fig. 27).

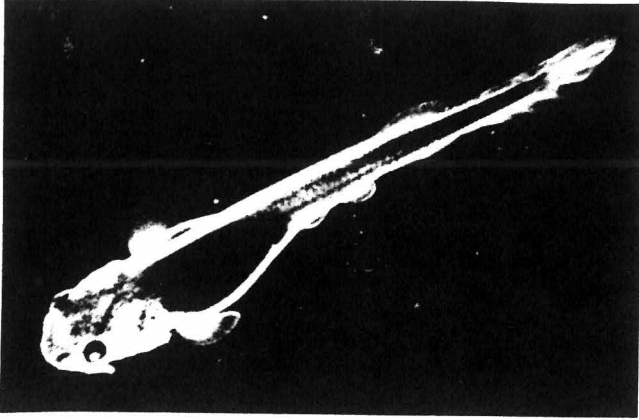

Fig. 26. White sturgeon, 10 days posthatch. (Beer 1981)

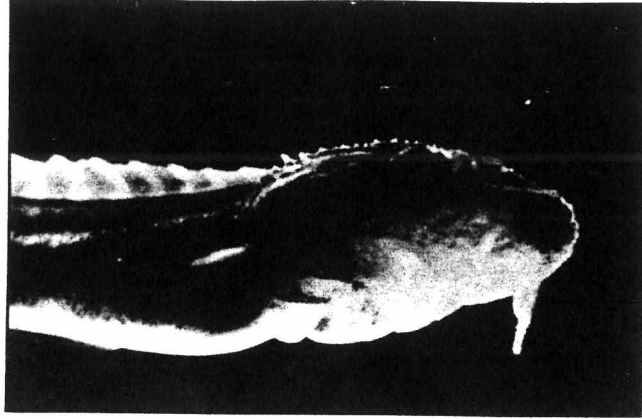

Fig. 27. White sturgeon, 18 days posthatch. (Beer 1981)

20 Days Posthatch

Lateral scutes are forming in a row dorsal to the lateral line. The head is now elongated and more streamlined, although many processes are still seen on the dorsal surface. Several rows of sensory pits are evident on the dorsal side of the snout. The larvae measure about 25.0 mm long.

SECTION IV

Broodstock Capture

Overview

Programs to establish captive broodstock of North American sturgeon have begun only in recent years, with emphasis on white sturgeon. The oldest F1 generation of hatchery-produced female sturgeon in North America are white sturgeon broodstock that are 8 years of age at this writing. Viable sperm from 3 and 4 year-old F1 males has been used successfully to fertilize eggs from wild-caught females, and fingerlings have been produced from these eggs. Females of the same year class are being monitored for ovarian development.

Until captive broodstock are available, broodstock are being obtained from wild stocks. The method of capture depends on each species' life habits, on local and national regulations, and on management policy. The fish may be taken from nonspawning, fattening areas prior to the reproductive migration, during migration, or directly from the spawning grounds after migration.

Broodstock are often selected from nonspawning areas to study the maturation process or to avoid disturbing animals that have migrated to the spawning grounds. This site selection also allows hatchery personnel to schedule hatchery activities in advance and to manipulate the spawning time of the fish. For migratory species such as the white sturgeon, prespawning broodstock may be taken from estuaries in the fall or winter just prior to the spring spawning period. When collecting sturgeon broodstock from nonspawning areas, large numbers of animals have to be captured and examined to obtain sufficient numbers of mature animals that will spawn within 6 months of captivity. The animals are not fed during this period.

Broodstock may also be taken directly from the spawning areas during the spawning migration when both eggs and sperm are ripe. Migration of reproductively active sturgeon usually occurs in the spring, with variations in time frame depending on the species and latitude. The methods used to capture sturgeon in spawning and nonspawning areas vary with local conditions and available resources.

Fish from Nonspawning Areas

Hatchery management of broodstock captured in salt water prior to their spawning migration requires facilities to maintain the animals during acclimation to fresh water before transport to the

hatchery. For white sturgeon, only about 20 percent of the total adult stock in the fattening area will be reproductively active because the interval between consecutive spawns in females is longer than one year. If the collection area is vast or located a significant distance from shore, three or more boats, preferably with radio communication, may be required. Small boats about 5.0 meters long are used for capture. The fish can be loaded onto the boat using a soft rope looped around its tail in combination with a hand net positioned over the head and the anterior one-third of the body. At the collection site, the sturgeon is placed in a small holding tank containing aerated water and transported to a larger processing boat for sex determination and gonad evaluation. The processing boat should have a large deck space capable of accommodating a holding tank for several sturgeon awaiting processing and a work area large enough for at least two personnel, two stretcher stands, and a stretcher (figs. 28, 29, and 30) to hold the fish in place during processing.

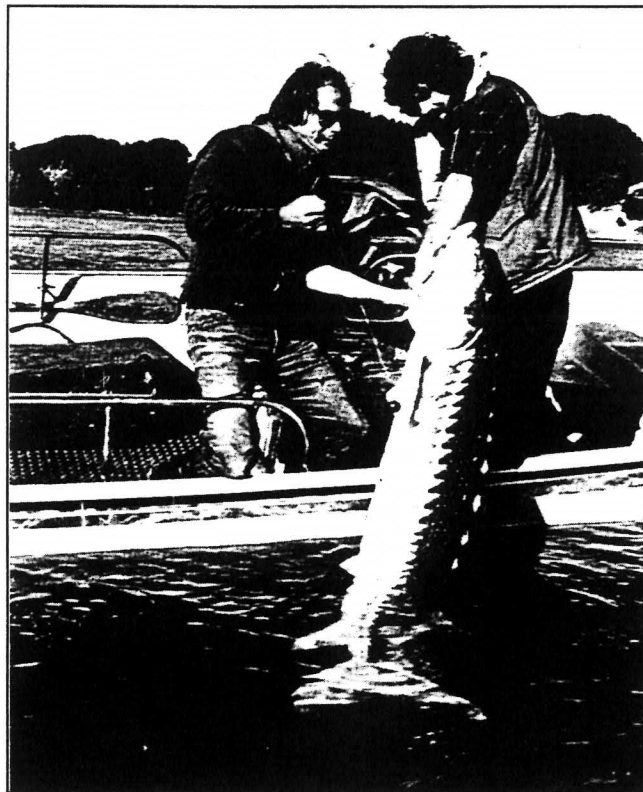

Fig. 28. Loading captured sturgeon aboard collection boat.



Fig. 29. Transfer of sturgeon between capture boat and processing boat.

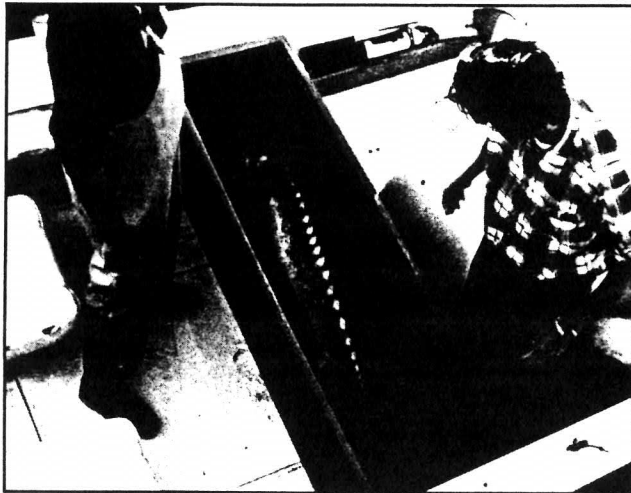

Fig. 30. White sturgeon in holding tank aboard small boat.

Upon transfer to the processing boat, the sturgeon is removed by net from the holding tank and moved to a stretcher positioned on the stretcher racks. A water tube is placed in the fish's mouth. While the fish is examined to determine sex and reproductive condition, the smaller boat returns to the collection site. If the fish is selected for broodstock, it is transferred to a larger holding tank on the processing boat and later transferred to a shore-based acclimation tank. After 2 or 3 days of acclimation to fresh water, selected broodstock are transported by tank-trailer to the hatchery, where they are placed in freshwater tanks to continue the physiological process of maturation.

Fish from Spawning Areas

Obtaining sturgeon from freshwater spawning areas usually involves fewer steps than from marine areas. The difference is that a greater percentage of the population will be reproductively active and possess mature gametes, and acclimation to fresh water is not necessary. Once a fish is captured, it is placed in a small holding tank on the boat and transferred to a shore facility. At the shore facility the fish is placed in a transport tank and taken to the hatchery.

Methods of Broodstock Capture

North American sturgeon broodstock are captured by a number of methods, including snagging, fishing with baited hooks, gill nets, and even by hand nets. Fishers select the method of capture based on the species and the successful fishing techniques of their area. This section will briefly cover these methods to illustrate the magnitude of effort involved in wild broodstock capture, but it is not meant to be a comprehensive explanation of the techniques used to fish sturgeon. Specific techniques for fishing sturgeon and capturing broodstock are described in the publications cited in the section references. Before fishing for sturgeon, check with your local state and regional federal fish and game agency for commercial and sports fishing regulations. State and federal regulations protect the species, and in many locations special permission is required to obtain wild broodstock.

Snagging

Snagging is not a legal method of harvesting sturgeon for sport or commercial fishing in many areas of the United States, but it is often used to capture large fish for scientific study or to obtain broodstock. The fish's skin is snagged with a hook that is attached to a retrievable line. Equipment used to snag sturgeon broodstock should be rated strong enough to handle fish up to 100 kg. This includes a rod and reel fitted with a line, weighted leader, and hook (figs. 31 and 32). If the fish can be seen resting on the bottom, the hook is lowered into the water, positioned next to the fish's body, and set in the fish's flesh by exerting an upward thrust of the rod. In situations where the fish cannot be seen, the hook is cast out from the boat and retrieved slowly through the water until resistance is felt, then the hook is set. Small size treble hooks are preferred when snagging broodstock. The hook is set under the large bony plates and is capable of securing the fish with minimal damage. Large size hooks often cause deep wounds and should be avoided (see Appendix 5 for the technique of snagging sturgeon).

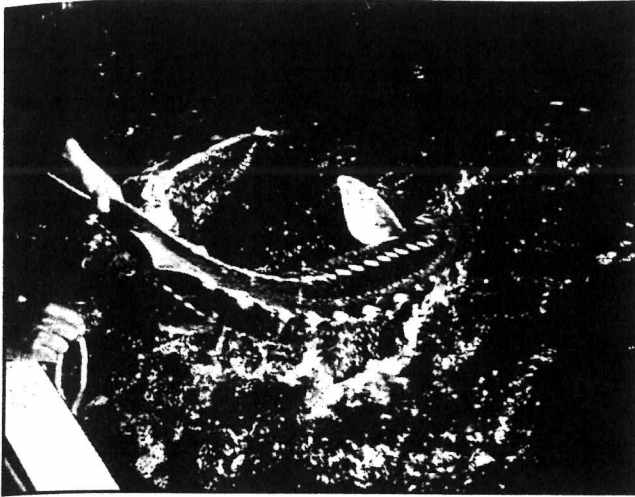

Fig. 31. Snagging sturgeon, San Pablo Bay, California.

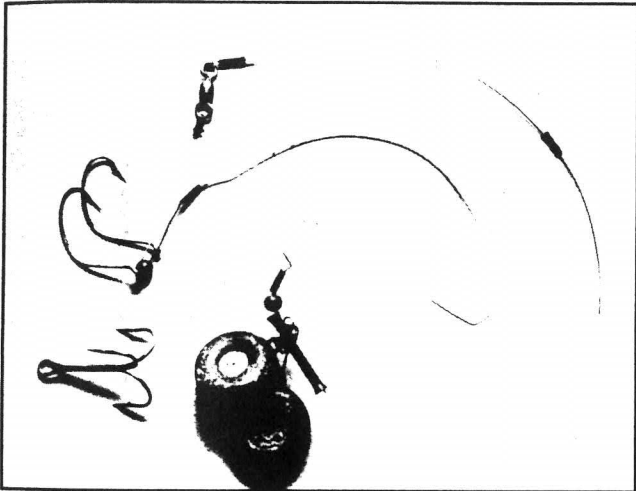

Fig. 32. Sturgeon snagging gear showing hooks, leader, and weights.

Snagging sturgeon is practical only when the fish are concentrated in an area free of obstructions that can entangle the fishing gear or foul the line once the animal is hooked. It is a method used primarily to capture prespawning broodstock prior to the reproductive migration but has also been used on the spawning ground. Capture is most efficient and successful when keyed to specific events that concentrate the fish in a defined area. For example, white sturgeon are obtained by this method during herring (*Clupea harengus*) spawns while the sturgeon are feeding on herring eggs deposited on submerged vegetation and other substrates. Sturgeon begin feeding on the herring eggs almost immediately after the eggs are deposited. Between feeding periods the fish can be seen

resting on the bottom. Herring spawning areas are often located by observing sea birds feeding on the deposited eggs or seals feeding on the herring. During peak spawning activities the water often has a milky appearance and a characteristic odor that some describe as similar to fish oil. During these periods sturgeon feeding on herring eggs are often seen rolling at the surface of the water. In San Francisco Bay white sturgeon have been taken successfully using these indicators during peak herring spawns between November and March.

Baited Hooks

Capturing sturgeon broodstock with baited hooks requires time and patience. It is not considered efficient in nonspawning areas because of the slow rate of capture and the limited chance of capturing broodfish suitable for hatchery work. This method is more successful in spawning areas, even though the catch is significantly lower than in prespawning areas. Virtually every white sturgeon caught in the spawning area is ripe and a potential spawner, therefore compensating for the number of hours of fishing effort.

The equipment used for this method is similar to that used in snagging. The fishing gear must be strong enough to handle large fish. To attract the fish, a suitable bait is placed on the hook. The rod is usually placed in a holder that is equipped with a bell or similar warning device to alert the fishers when the boat is moved. Although fishing may be done from shore, most workers will fish from a boat to have maximum access to the river and room to maneuver after the fish is hooked.

Gill Net

Gill netting is an effective method of capturing broodstock. Like snagging, it is most effective when used on a concentrated population of sturgeon moving through a spawning area. This method requires more labor than snagging and often results in stress to the fish. A major problem is that fish can become tangled in the net. Postcapture mortalities from the use of gill nets on the Columbia River in the United States and in Russian waters have been substantially higher when compared to snagging. However, gill netting has been used successfully in both spawning and nonspawning areas to capture broodstock sturgeon.

Capturing sturgeon by gill netting is a challenge because variable river currents and bottom conditions, such as snags and rocks, can damage the fishing gear. In the marine environment nets may be damaged by boats, and by sharks, rays, and other large fish. In rivers the gill net is usually set from a small to moderate-sized boat 4.0 to 6.0 meters long that is suitable for the conditions encountered. The boat should have adequate deck

space for handling the net and captured fish. The net should be long enough to span the river channel used by the sturgeon, made of 25.4 to 35.6 cm stretched mesh, and equipped with appropriate floats, flags, and lights for night operations. The amount of weight used should be geared to the strength of the river current. Gill nets of 33.0 to 40.6 cm stretch mesh are also used in the marine environment. Methods include anchoring one end on the beach with the other end free and drifting the net through a sturgeon migration area.

The gill net should be checked about every 2 to 4 hours because female sturgeon left entangled in the net for longer periods are often stressed or killed. In some areas that are accessible only at high tide, it may only be feasible to check the nets once a day. Any time the floats show signs of activity, the net should be checked immediately. Captured fish should be transferred immediately to an appropriate holding or transport tank. Extreme care should be taken with captured animals

because some females will be near ovulation, and the eggs are easily damaged and the fish stressed. When transferring the fish from net to boat or from boat to tank, care should be taken to maintain the fish in a horizontal position with as little pressure as possible to the abdominal region.

Handnetting

Capture of lake sturgeon broodstock with a hand net has been done successfully and efficiently in some spawning areas. Lake sturgeon in the Wolf River in Wisconsin congregate and spawn in small, clear-water areas at the base of dams and are readily accessible for capture in shallow areas near shore. An individual equipped with a reinforced pole net captures the fish by placing the mouth of the net over the head end of the fish and sweeping it down over the body. The fish can then be examined near the shore or transferred to a transport tank (fig. 33).



Fig. 33. Handnetting lake sturgeon broodstock. (Photo courtesy of the Wisconsin Department of Natural Resources)

SECTION V

Broodstock Handling, Transport, and Holding

Overview

Sturgeon broodstock are often large animals that require special equipment for handling and maintenance. When possible, broodfish weighing more than 70.0 kg should be avoided. These fish are easily injured when removed from water, require mechanical lifting equipment and, if not handled properly, can easily injure hatchery personnel. Atlantic sturgeon broodfish often exceed this weight limit and should be handled with mechanical support systems, using care to prevent injury to the fish or hatchery personnel (fig. 34). Equipment for moderate-sized fish is designed to enable hatchery personnel to move and manipulate the sturgeon without causing injury to the fish or personnel.

Different tank equipment and techniques are also required to prepare sturgeon broodstock for spawning. Tank systems for holding broodstock are of a flexible design that allows the equipment to be used for specific objectives and for other uses as requirements in the hatchery expand. The applications depend on whether the fish were captured prior to the spawning migration or in a preovulatory condition in the spawning area. The tank systems must be capable of maintaining ripe animals in peak condition before spawning and of providing a suitable environment to promote maturation of potential reproductive stock.

Water criteria for sturgeon hatcheries have not been defined for North American species. The success of present day hatcheries has resulted from selecting sites where the water has been used successfully in hatcheries for other species of fish, or where the water parameters are comparable to criteria established for other species. The chemical and physical criteria established for salmonids is a good base from which to start and may be used until criteria for sturgeon have been defined. Some of the suggested parameters are defined in table 3.

Sturgeon Support Equipment: Individual

The methods described here for handling sturgeon broodstock have been used successfully in sturgeon hatcheries. Hatcheries will continue to modify techniques and equipment and will develop methods designed to minimize stress to the animal and increase the efficiency of hatchery personnel.

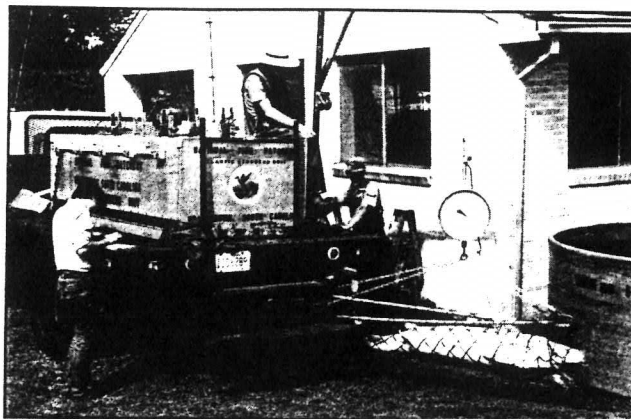

Fig. 34. Power sling and weight scale used for large Atlantic sturgeon broodstock. (Photo courtesy of the South Carolina Department of Natural Resources and the U.S. Fish & Wildlife Service)

TABLE 3. Suggested water-quality criteria for a sturgeon hatchery*

Chemical	Upper Limits for Continuous Exposure
Ammonia (NH ₃)	0.0125 mg/L (un-ionized form)
Cadmium	0.004 mg/L (soft water 100 ppm alkalinity)
Cadmium	0.003 mg/L (hard water 100 ppm alkalinity)
Copper	0.006 mg/L in soft water
Hydrogen sulfide	0.002 mg/L
Lead	0.03 mg/L
Nitrogen	Maximum total gas pressure 110% of saturation
Nitrite (NO ₂ ⁻)	0.1 mg/L in soft water, 0.2 mg/L in hard water (0.03 and 0.06 mg/L nitrite nitrogen)
Ozone	0.005 mg/L
Total suspended & settleable solids	80 mg/L or less
Zinc	0.03 mg/L

Chemical	Criteria
Oxygen	5.0 mg/L to saturation
Carbon dioxide	0.0-10.0 mg/L
pH	6.5-8.0
Total hardness (as CaCO ₃)	10-400

* Based on a modification of criteria identified for salmonids by Wedemeyer (1977).

These techniques represent a good starting point in developing techniques that best fit the individual hatchery operation and the needs of the sturgeon species.

The support equipment is used to handle individual sturgeon and move large fish safely and efficiently. It is also designed to maintain the animal during surgical examinations and gamete

removal. Whenever sturgeon are removed from a tank, transported, or otherwise handled at the hatchery they are subjected to stress that can lead to disease. To reduce stress-related bacterial and fungal infections, the sturgeon are given a prophylactic salt treatment when they are returned to the holding facility, and regularly during the holding period (see Appendix 6 for technique).

Tube Net

A tube net is 2.4 meters long and composed of small-mesh net, with each end held open by a hoop frame attached to pole handles (fig. 35). The two handles also provide leverage at both ends of the net when moving the fish, which is also supported by lifting the center section of the net. Tube nets can be used at the capture site to move fish into or out of the boat and at the hatchery to move fish between tanks and onto the stretchers.

Stretcher

A stretcher is used to transport larger species of sturgeon short distances around the work area and to hold the fish during examination and processing. The sturgeon's axial skeleton is cartilaginous, and the stretcher distributes the weight evenly preventing injury to the internal organs when the fish is moved or supported. A stretcher is also recommended for use with smaller sturgeon, as they can be quite active under examination and difficult to restrain without injury to the fish. Sturgeon moved by hand or in a net are often subjected to excessive hand pressure, easily dropped, or even torqued while in a net. Any of these actions are detrimental to broodfish. During examination of the fish the stretcher is supported by notched racks or saw horses (figs. 36 and 37).

The stretcher for moderate-size fish (35-45 kg) consists of smooth, nonabrasive, fiber-reinforced nylon sheeting attached to two 2.4-meter poles; it is capable of supporting at least 114.0 kg. The width of the stretcher is such that during transport the poles may be brought together to further restrain the animal. The stretcher has a hood at one end that covers the fish's head and serves as a respiration chamber when flooded with water. During transport the sturgeon is positioned in the stretcher dorsal side up. During processing the sturgeon is positioned ventral side up with its head placed in the hooded canopy. This canopy further restrains the animal and positions the mouth to receive a watertube (fig. 38). A sturgeon may be transported or held in the stretcher for periods of up to 10 minutes without watertube backup as long as the temperature is moderate and the fish is kept moist. Preferably, sturgeon are held without the watertube for no more than 3 minutes.



Fig. 35. Tube net used to capture and restrain medium-sized sturgeon broodstock.



Fig. 36. Transferring sturgeon broodstock from a tube net to a stretcher.



Fig. 37. Transporting sturgeon broodstock to a work area by stretcher.

Watertube

The watertube is a 2.5 cm diameter tygon tube connected to a source of non- or dechlorinated water. It is positioned in the sturgeon's mouth to provide a flow of oxygenated water over the gills and out the gill apertures. The stretcher poles are placed on supports that provide a slight downward incline causing the water to flood the canopy containing the head of the fish. The system is used to maintain the fish during long periods of examination and processing (figs. 39 and 40). The flow rate should be adjusted to flood the gill cavity and provide a reasonable water exchange. Excessive water flow does not provide a good oxygen exchange and may stress the fish.

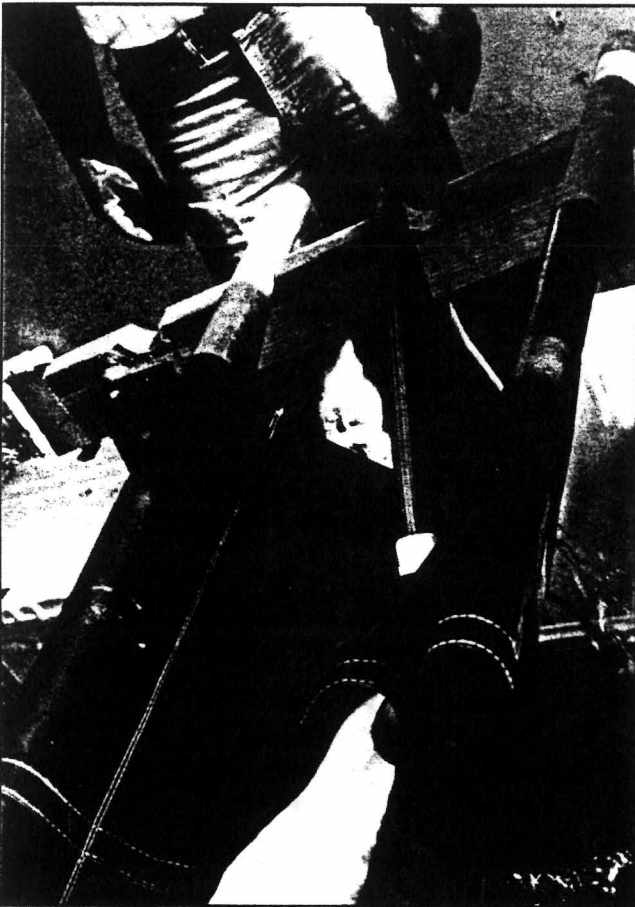

Fig. 38. Sturgeon stretcher positioned on a notched sawhorse.

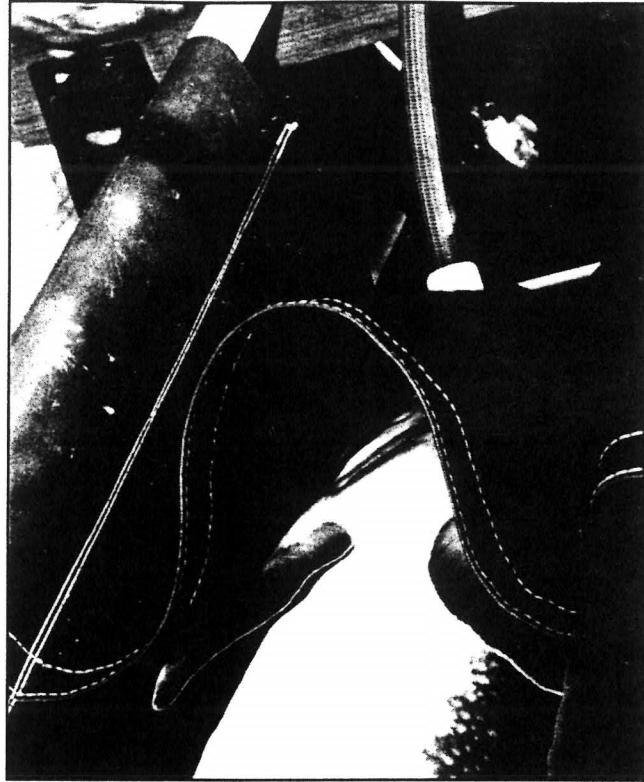

Fig. 39. Close view of watertube and stretcher hood in use.

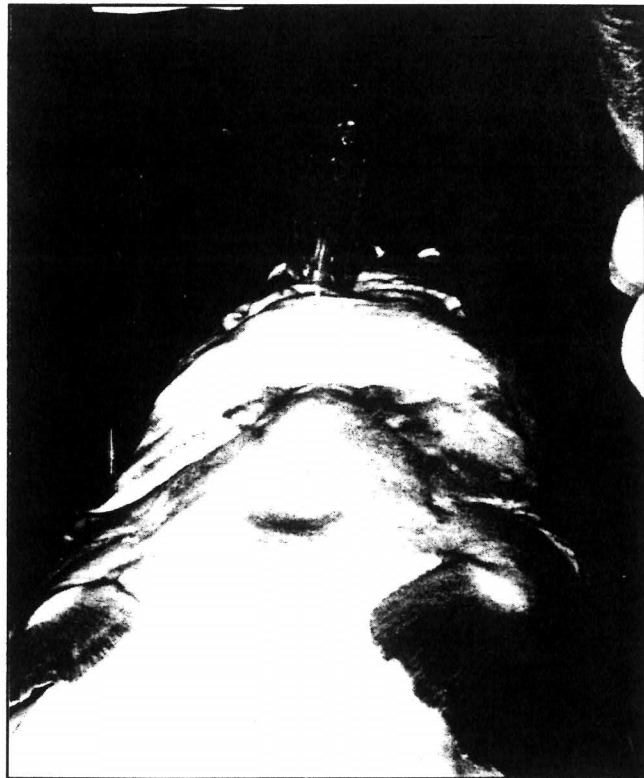

Fig. 40. Close view of watertube extending through the stretcher hood and into the sturgeon's mouth.

Sturgeon Tanks and Applications

The size of most sturgeon broodstock requires large, well-constructed tanks, preferably able to serve multiple functions. Tanks may be constructed of a wide variety of materials including wood, concrete, fiberglass, and plastic. Fiberglass tanks are often used because of their strength and portability. These tanks must be capable of maintaining the animals in good condition during transport and while holding them for short or long periods. Field and transport tanks should be designed for the specific field conditions encountered, the nature of the broodstock being used, and the distance from the capture site to the hatchery. All of the tanks described in this section represent designs that have been successfully used to rear sturgeon and are presented here as examples. Among good criteria for a culture tank are good water circulation, designs for cleaning efficiency, easy access, and durability.

Short-Term Holding

If the water quality is good, individual sturgeon may be transported or held in small tanks containing nonaerated water for up to 30 minutes. The water should be aerated initially, and the water temperature should be 15° to 17°C. The minimum-sized container should be slightly larger than the fish, fitted with a cover, and provided with enough water to fully support the animal to prevent bruising and internal injury (fig. 30).

Broodstock from nonspawning areas are often transported in small tanks when moved from the capture site to larger boats for gonadal processing or to shore facilities for acclimation and further transport. Good judgment should be used when employing these techniques. When some form of aeration or water exchange is available, it should always be used. When aeration is not available during transport, exchange of water with a hand bailer can add an extra margin of safety. Ripe broodstock should always be provided with aeration and the best possible water quality.

Moderate-Term Holding and Transport

Sturgeon are often held in tanks for several hours or even several days during isolation, observation, and treatment, or while in transport to another location. A well-designed tank for holding broodstock during these activities is rectangular in shape, 1.8 to 2.1 meters long, 0.46 to 0.91 meters wide, 0.61 to 0.91 meters deep, and has a capacity of 500 to 1,500 L (figs. 41 and 42). The tank should be provided with a water exchange to maintain 5.0 mg/L oxygen and good water quality. A maximum loading density is about 150.0 kg/m³.

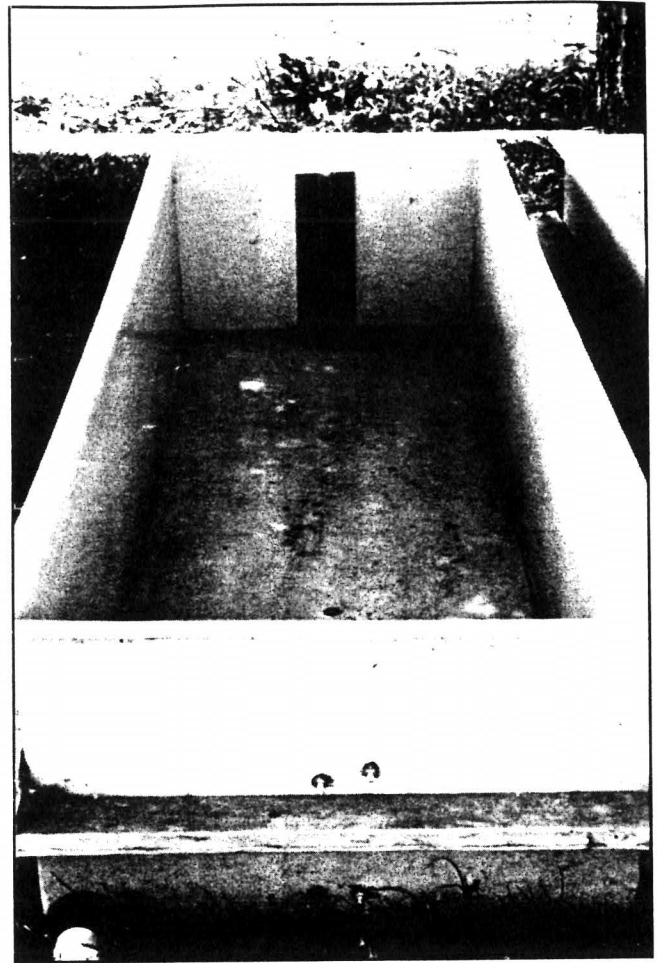

Fig. 41. Fiberglass tank for holding sturgeon females during hormone-induced ovulation.

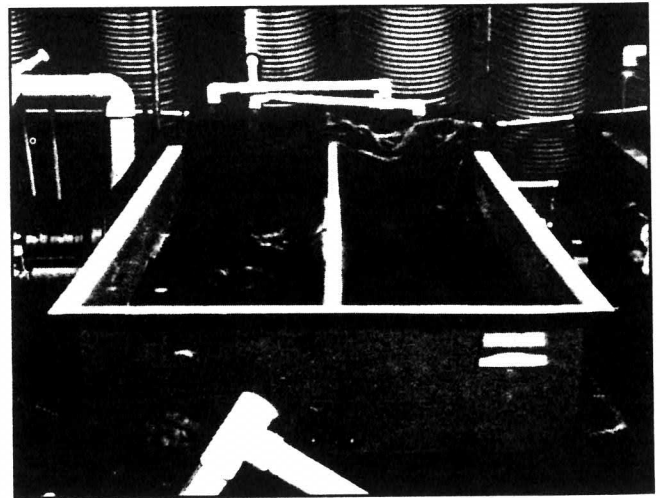

Fig. 42. Double-sided fiberglass holding tank used to maintain two individual sturgeon females during observation.

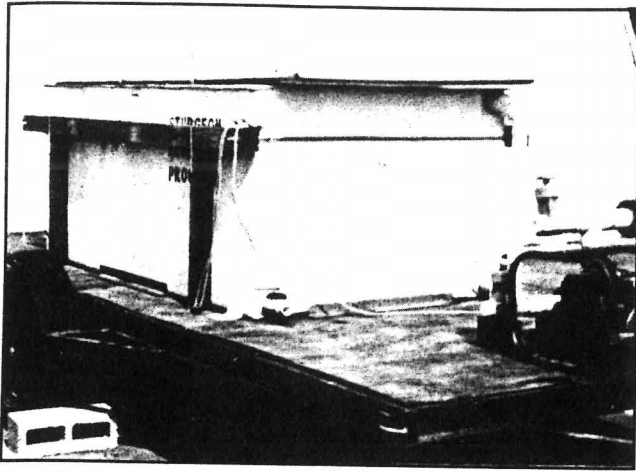

Fig. 43. Insulated fiberglass transport tank for sturgeon broodstock mounted on a double-axle trailer and equipped with a water circulation system and supplementary aeration.

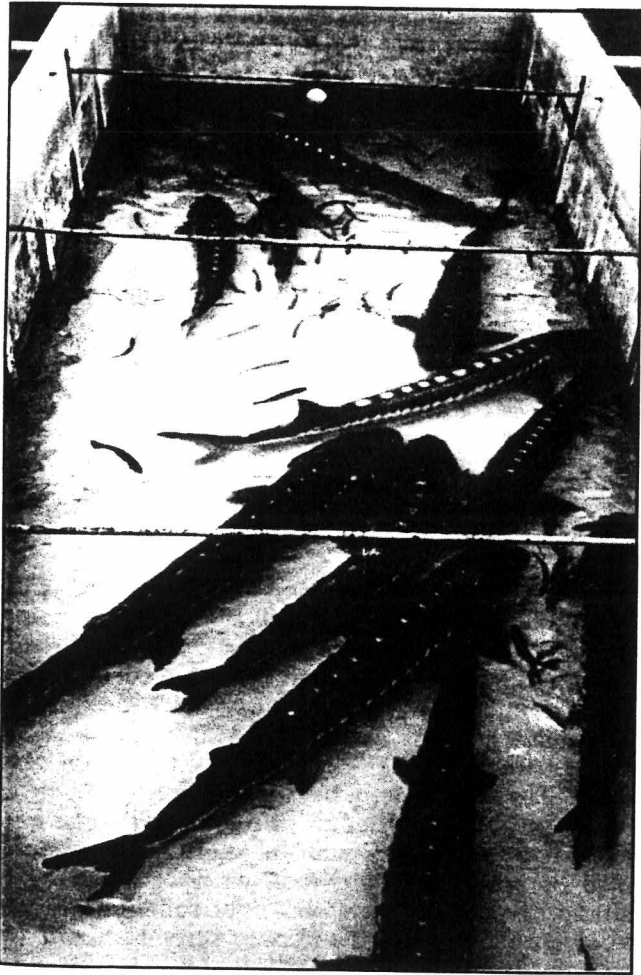

Fig. 44. Fiberglass acclimation tank for sturgeon captured in salt water.

Transporting broodstock by road is a necessary and critical operation that requires dependable equipment designed to maintain the sturgeon with minimum stress. Insulated fiberglass tanks of about 1,500-L capacity with an attached cover are recommended (fig. 43.). Aeration should be provided by a forced-air compressor or bottled oxygen, and a back-up oxygen system should be included in the design. More elaborate designs include an internal water recirculating and spray system. The trailer should be rated as 4-ton minimum and equipped with a heavy duty double axle and the necessary tools to change tires while on the road. A well-designed system will allow for a 48-hour transport. A loading density of about 150.0 kg/m^3 is also recommended for transport tanks.

Short trips of 1 hour or less may be made using a modified tank as described for isolation and treatment. Such a tank, however, should be well insulated, covered, equipped with an aeration system and back-up, and mounted on a heavy duty trailer.

Acclimation Tanks

Acclimation tanks are used with prespawning broodstock collected from salt- and brackish-water areas. White sturgeon are usually conditioned to freshwater before they are transferred to the hatchery to continue the maturation process. Acclimation tanks are set up near a salt water location with access to a chlorine-free, freshwater source. Initially the sturgeon are placed in tanks filled with salt water, then over a period of 2 to 3 days the water is exchanged and the salinity reduced until the water is fresh. This gradual transition and acclimation also allows the fish to recover before being transported to the hatchery. Sturgeon have also been transported successfully to the hatchery in diluted sea water after recovery and partial acclimation. When this is done, the acclimation process is continued at the hatchery.

Acclimation tanks for white sturgeon are designed to hold 25 to 30 fish of 23.0 to 46.0 kg each because large numbers of prespawning broodstock are usually taken to assure availability of future spawners. The tanks are rectangular or circular with a minimum depth of 0.91 m and a capacity of at least 10,000 L (fig. 44). Water exchange is provided with a dual pump system capable of delivering 57 L per minute of both fresh and salt water. Aeration is supplied with a forced air system with back-up capabilities. The tanks are covered or screened for sun protection and security and to minimize animal disturbance.

The acclimation process is not necessary when broodstock are collected from freshwater

spawning areas. These fish may be transported directly to the hatchery after they have recovered from the stress of capture. Before transport the fish are often allowed to recover in a short-term holding tank equipped with aeration and water exchange systems.

Maturation Tanks

Maturation tanks are designed for long-term maintenance of broodstock. These systems are capable of maintaining the sturgeon for several months and in a condition that promotes maturation. They are used during the maturation of pre-spawning adults captured before the spawning migration.

A recommended design for a maturation tank for domestic broodstock is a 6.1-meter diameter circular fiberglass tank with a center drain. Water level is maintained by an external standpipe (figs. 45 and 46). The tank consists of at least two sections to allow for convenient transport and easy assembly. It has a maximum capacity of 40,000 L and a water depth maintained at 0.61 meter, which gives an approximate 20,000-L working volume. Water exchange is provided at a 76.0 L/minute minimum and O₂ is supplemented by a forced air system that maintains a minimum concentration of 5.0 mg/L. Water is introduced at an angle to promote a spin that aids in removing waste through the center drain.

The tank should be covered and located in a secluded area to reduce animal disturbance. Aeration may or may not be necessary, depending on available water flow, animal density, and oxygen content of the initial water. To assure adequate oxygen content in the tank, however, the oxygen content of the effluent water should be maintained at or above 5.0 mg/L. Water exchange rate in the tank should be at least 10 to 15 volumes per day exchange when loaded to capacity. Capacity loading is about 15 broodfish with a mean weight of about 30.0 kg.

The water temperature of the long-term holding tanks for wild-caught broodfish should be maintained at the temperature experienced by the natural population of the species during normal maturation. For most North American sturgeon, this temperature is between 10° and 15°C. Proper site location of the hatchery is important. A site with several water sources of varying temperature is valuable, because the ability to blend water with thermal valves is cheaper than heating or cooling water to the proper temperature. Natural populations of white sturgeon spawn in the Sacramento River between 13° and 17°C, with peak spawning occurring at about 15°C. White sturgeon males have been successfully matured in California hatcheries using these temperature criteria.

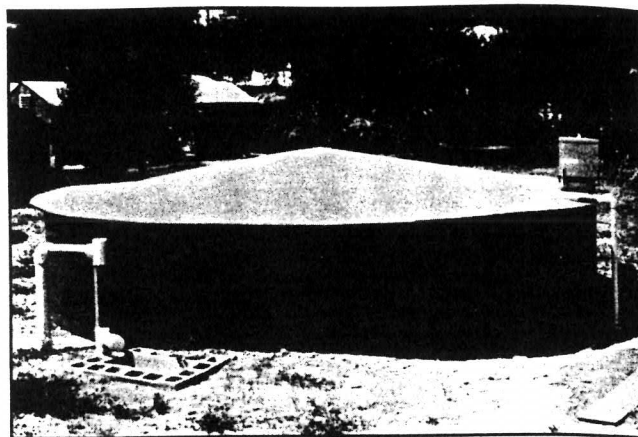

Fig. 45. Six-meter diameter fiberglass tank with peaked fiberglass sectional roof used for long-term holding and as maturation tanks for sturgeon broodstock.

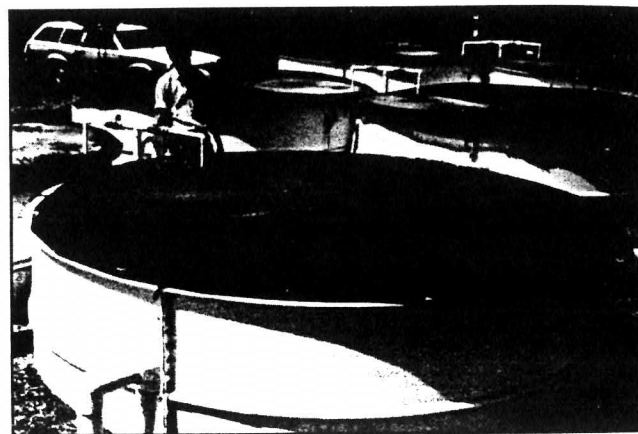

Fig. 46. Three and a half-meter fiberglass tank with screen roof used to maintain sturgeon broodstock.

Spawning Tanks

Spawning tanks for handling sturgeon broodstock should be of a size adequate for the species being handled. Most tanks are rectangular, with dimensions that prevent the animal from turning, yet allow some movement. A good tank design for white sturgeon in the 23.0 to 46.0 kg class is 2.1 meters long by 0.61 meters wide by 0.61 meters deep. The tank should be raised to a height convenient for handling the fish and for moving the fish in and out of the tank with the stretcher. It should also be covered or provided with a strong mesh shade screen that provides subdued lighting yet allows observation. The cover screen should be secured by rope or blips to prevent the fish from leaping from the tank or splashing the work area if excited (fig. 47).

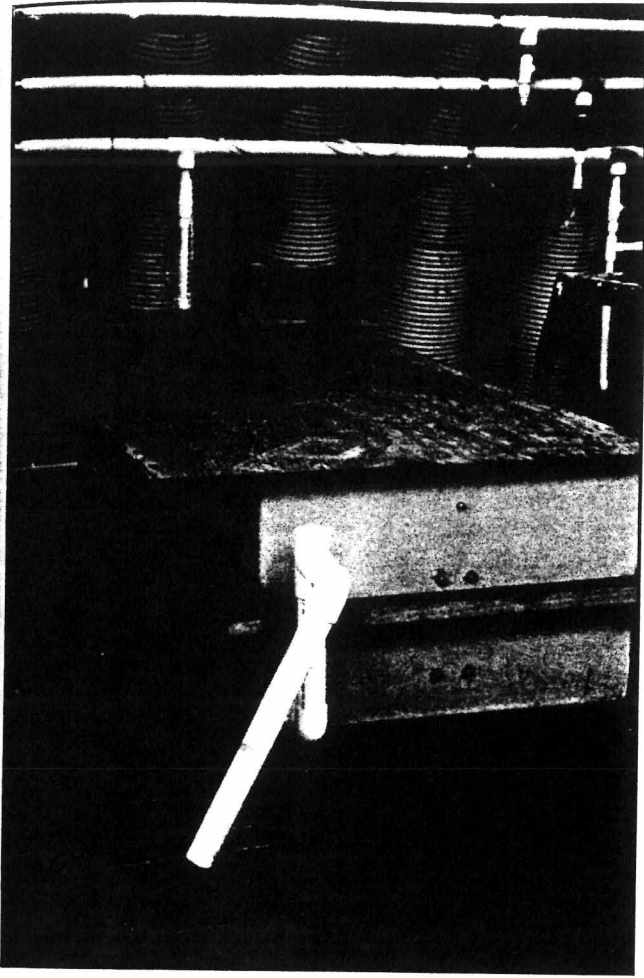

Fig. 47. Fiberglass tank with plywood cover used to spawn sturgeon broodstock.

The interior of the tank is usually medium blue or medium green in color to prevent strong light penetration and to aid viewing of the darker colored eggs once the female begins ovulation. The water temperature is maintained at the recommended spawning temperature range for the given species (table 1), and the water exchange is about five or more volumes per hour to maintain good environmental conditions. Supplementary aeration to the system is recommended.

SECTION VI

Broodstock Evaluation: Field Examination

Overview

Sturgeon broodstock are examined after capture to determine their sex and reproductive condition. Because sturgeon in general do not exhibit external sexual dimorphism, the ease with which this task is accomplished depends on the season, whether the fish were taken from a spawning or nonspawning area, and whether or not the fish were actually participating in a reproductive run. Under any circumstance the objective is to determine the sex and the relative level of maturation with minimum stress to the fish. Excessive stress to potential broodfish can result in harm to the fish or loss of its ability to contribute viable gametes in the hatchery. In some circumstances surgery may be necessary to determine the sex or reproductive condition of the animal. Unless necessary, however, surgery should be avoided, as it does stress broodfish.

Although sexual dimorphism is not apparent in most sturgeon, ripe sturgeon collected in spawning areas often exhibit secondary signs that will indicate their sex. If not freely milting at the time of capture, males can be easily identified by applying pressure to the posterior abdominal region, thus causing milt to be expressed from the genital opening. Females are recognized if their abdomens are obviously swollen and girths enlarged. Small females, possibly spawning for the first time, are more difficult to evaluate for ripeness or sex. Although they may be suitable for spawning, these fish are often mistaken for nonmilting males or immature, nonripe females, and surgery may be required to determine their sex and reproductive condition. It is often difficult to distinguish the sex of sturgeon taken from greater depths, such as the Columbia River. Male sturgeon taken from a depth of 30 meters or more often will exhibit distended girths caused by air bladder pressure and may be confused with roe-bearing females.

It is more difficult to determine the sex and reproductive condition of sturgeon taken from nonspawning areas prior to their reproductive migration, although certain observations may help (see Appendix 7 for tips on identifying female sturgeon just before spawning migration). Large female sturgeon with late stage vitellogenic eggs that are captured prior to entering the spawning area will exhibit a swollen abdomen and enlarged girth. These fish are often transported to the hatchery to continue the maturation process. A

swollen and enlarged condition that is caused by extensive feeding will be apparent after the fish are held for a few days without feed and the gut is void of waste. Male sturgeon taken from nonspawning areas often present a problem when undergoing evaluation for sex or level of maturation. They are difficult to distinguish from immature, nonripe females, and surgery is required if the objective is to obtain males and verify their reproductive state.

Taking broodfish from the spawning ground at the height of the spawning season eliminates the need for surgery to determine sex and condition. This process reduces both the work necessary for hatchery success and the handling stress on the captured broodstock. As stated, however, in some circumstances capture of broodstock from nonspawning areas is preferable and surgery is necessary. This approach is selected if the objective is to avoid disturbing fish that have completed a spawning migration or because of regional social or political problems that may develop if broodstock are captured in a spawning area. An important advantage to this approach is that it enables hatchery personnel to manipulate the spawning time of the fish and plan hatchery events in advance.

Two tests are available to determine the stage of development of sturgeon follicles and their receptiveness to hormonally-induced ovulation. Both require surgery. The first test allows classification of late-stage maturity in eggs based on egg polarization and position of the nucleus or germinal vesicle (GV) and is used to select female sturgeon that are good candidates for spawning during the immediate hatchery season. Although the test is not essential to hatchery protocol using captured white sturgeon broodstock, it is presented here for two reasons: it is useful in domestic broodstock research and may become more important in hatchery work with other North American species. The disadvantage of the test is that it is based only on morphological criteria and does not evaluate the physiological condition of the follicles.

The second test determines the ability of the oocytes to respond normally (i.e., undergo GV breakdown) to the hormones administered during spawning induction and is used to determine if the female sturgeon is ready to undergo induced spawning. It is considered essential to the hatchery operation.

The test for GV position is optional. It is presented in this section under the heading "Field Evaluation of Broodstock: Surgical Examination" because the sampling process may be conducted immediately after fish are captured or just prior to the spawning period. Methods of gross evaluation of gonads are presented in the same section but can also be used to evaluate broodstock maturation in the hatchery. The second test, for GV breakdown, is covered in Section VII (pages 45-47).

Field Evaluation of Broodstock: Surgical Option

Surgical examination in the field to determine sex or level of maturation may be performed on a moderately sized boat or at a shore-based facility. All surgical and other support equipment should be laid out beforehand. The necessary surgical equipment is listed in table 4.

TABLE 4. Equipment used for field examination of sturgeon broodstock

Hooded stretcher	Stretcher rack
Watertube	Watertube circulation pump
Watertube sump	Wash bottle with 4% nitrofurazone
Razor blades	Scalpels with #10 and #15 blades
Forceps, suture needle	Forceps, Adson-Brown tissue
Hemostats, straight and curved	Forceps, common, straight, and curved
4.0-5.0 mm tygon tubing	Leibovitz L-15 incubation medium
Sample vials, 50 or 100 ml	Identification tags
Record book	Tape measure
Scale	150-ml beakers
Hot plate	Dissecting microscope
Shallow tray, 12" x 24"	Crushed ice
Paper towels	
Monofilament suture material swaged to half-circle surgical needles	

Whether or not to anesthetize the sturgeon in the field before the surgical examination is decided by the hatchery personnel. The purpose of using an anesthetic is to prevent the fish from moving during the surgery. West Coast operators prefer not to anesthetize the fish, as they have found that following the stress of capture, the sturgeon is exhausted and does not move during the minor surgery. More important, the combination of exhaustion and anesthetic can be detrimental to the fish. However, these operators do use anesthetic during surgery at the hatchery while surgically evaluating the sturgeon's level of maturity. The anesthetic of choice is MS-222 (Federal Food & Drug Administration-approved anesthetic for fish). See Final Female Selection: Preassay Surgery, page 45.

Surgical Examination

After capture, the fish is quickly transferred to the examination site, where it is placed on its back in

a stretcher and positioned on a stretcher rack. A watertube is placed in the animal's mouth and constantly monitored to see that the water flow is maintained and the stretcher hood flooded. In preparation for surgery, the abdominal area anterior to the genital pore is treated with a 4 percent antibacterial solution of nitrofurazone administered with a wash bottle (for method, see Appendix 8). Using a scalpel fitted with a size 10 blade, a 1.0 cm incision is made through the ventral midline, a distance of three to five ventral scutes anterior to the genital pore. This incision is made to determine the presence or absence of ripe oocytes (fig. 48). If the fish is a ripe female, the ripe oocytes will appear as large, 3.5 to 4.0 mm diameter, dark-pigmented eggs in the area of the incision. Ripe testes can also be recognized through a small incision as a white spermatogenic tissue. If spermatogenesis is not advanced, the testicular lobes will be yellow with a dark-pigmented tunica. If the fish is immature and the gonads are underdeveloped, a biopsy of the tissue may be taken to determine the sex.

The incision is then enlarged to about 2.5 to 3.0 cm. Gonads are examined by gently pushing aside the gut with an arm of the forceps. Immature testes are uniform, yellow, cordlike structures with a white stripe of spermatogenic tissue at their ventral portion. The ovaries are more flattened, white to pale pink in color, with the ovigerous folds exposed on the lateral side adjacent to the body wall. Small samples up to 5.0 x 5.0 mm can be taken with biopsy forceps or cut out with a thin blade scalpel if study samples are desired. These samples can be taken from the superficial tissue layer without damage to the major blood vessels.

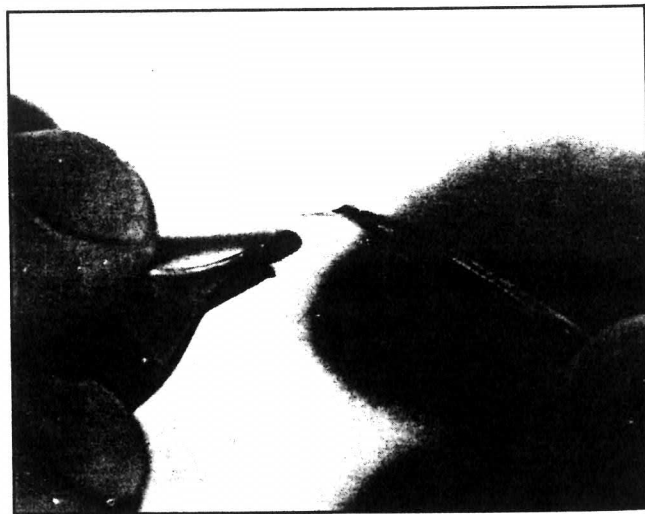

Fig. 48. Initial incision made during the surgical examination of sturgeon broodstock.

If the gonads are small and not readily available for visual examination, they can be examined by palpation. Sex may be determined by carefully inserting a finger through the cut into the body cavity and feeling the shape, size, and texture of the gonad (fig. 49). Before insertion, the finger is disinfected with nitrofurazone and a small amount is also washed into the body cavity.

The male and female gonads are easily differentiated by touch. The ovary is not membrane-bound, has a bumpy texture, and feels rough when touched. The testis is covered with a thin membrane and feels smooth. The difference in texture of the male and female gonads is evident at all stages of sexual development (table 5 and Appendix 9).

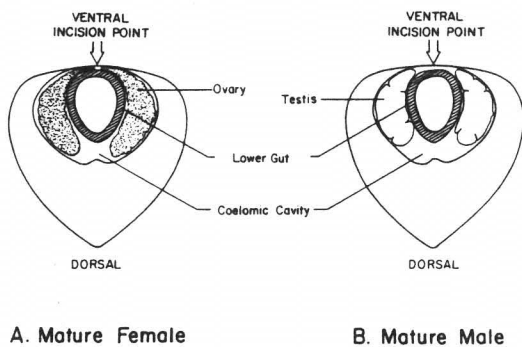

Fig. 49. Diagrams of cross-section through lower third of body of sturgeon broodstock, showing the position of the gonads, in (a) mature female and (b) mature male.

TABLE 5. Gross characteristics of ovaries and testes of white sturgeon notable during surgical examination

Stage	Ovaries	Testes
0	Gonad apparent only as undifferentiated tissue.	Gonad apparent only as undifferentiated tissue.
1	Small ovary: folded; no visible oocytes; tissue color white to yellowish.	Testis appears as thin strip of tissue; some adipose tissue; no pigmentation in tunica.
2	Moderate-size ovary: small 200-500 μ m oocytes; profuse adipose tissue; sometimes "salt & pepper" -like particles present; "salt:" developing follicles; "pepper:" atretic follicles.	Small testis: beginning folds may be apparent; high adipose content; tunica with some "translucent smokey" pigmentation.
3	Large ovary: varies in color from white to yellowish to light gray; oocytes 1.5-2.5 mm; sometimes with "salt & pepper" appearance.*	Large testis: some adipose tissue; folds beginning to form lobes; some pigmentation in tunica still apparent.
4	Presence of large, dark oocytes, 3.0+ mm.	Large, lobular white testis.†

* The stages are relative, and as transitions are made between stages, gradations between stage characteristics may be apparent.

† Mature testis will not exhibit pigmentation in the tunica. Advanced Stage 3 testes have been used to obtain sperm, but sperm viability is often reduced.

Direct observation of the gonads or other internal organs can be made with an otoscope supplied with a battery operated light source. This instrument allows examination of the gonads with minimum disturbance to the animal. It is inserted through the incision and allows an adequate view of the internal organs.

Staging the Male

The developmental stage of the male is determined during primary processing. The size and color of the testis are the criteria for judging ripeness. A ripe testis appears creamy white, regardless of its size. An unripe testis has a significant amount of dark pigmentation and yellow fat deposits. The white germinal portion of an unripe testis is greatly reduced when compared to a ripe testis. If an otoscope is not available, the incision may have to be enlarged to 4.0 to 6.0 cm for proper visual examination. Whenever possible, such enlarged incisions are avoided as they reduce the chance for fast healing following closure.

Staging the Female

Oocyte samples can be taken from the female at this time to determine if the fish is a potential spawner by determining GV position. The oocytes are removed by aspiration using a length of 4.0 mm-internal diameter tygon tubing. A small amount of chilled Leibovitz L-15 incubation medium or saline solution is first drawn into the tube to facilitate oocyte passage in the tube (figs. 50 and 51). See Appendix 10 for alternate incubation medium. Once the tube is inserted into the ovarian mass, the incubation fluid is released, and a sample of about 50 oocytes is drawn into the tube. The oocytes are placed in a 50.0-cc vial containing enough incubation medium to cover the sample, and the vial is marked to identify the fish. The sample may be stored on ice and processed at a shore installation later in the day.

Postsurgical Procedures

After examination, the incision is closed and sutured using a cruciate or continuous suture pattern (figs. 52 and 53). (For materials needed, see Appendix 11.) The suture should not be tight and should provide 2.0 to 4.0 mm slack to prevent the suture material from cutting into the tissue as it swells during the healing process. The surgical area is then washed with a 4 percent solution of nitrofurazone.

Immediately after surgical examination, an identification tag is placed on the animal and the data related to the tag recorded. These data typically include capture date and location, length of the fish, and sex and stage of maturity. Ideally, the tag should be readable without handling the fish.



Fig. 50. Removal of an oocyte sample from the body cavity of a female sturgeon by the aspiration technique using a tygon tube inserted through an incision in the body wall.

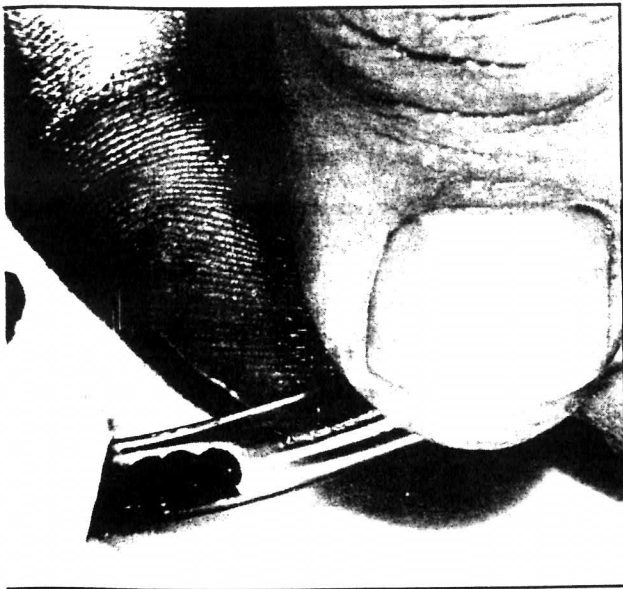

Fig. 51. Close view of the tygon tube used to remove an oocyte sample from a female sturgeon.

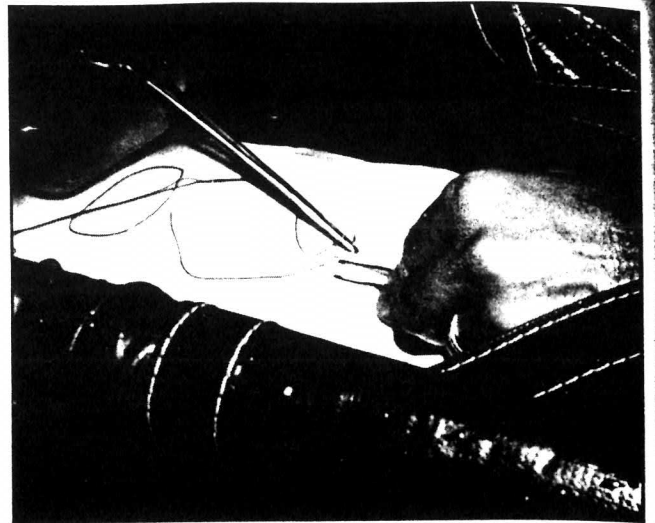
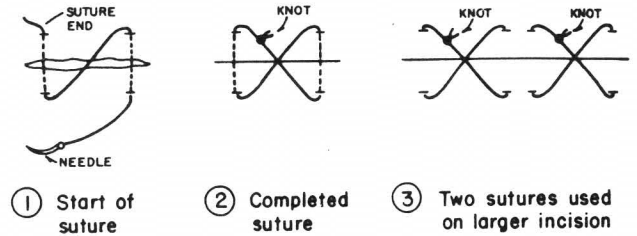
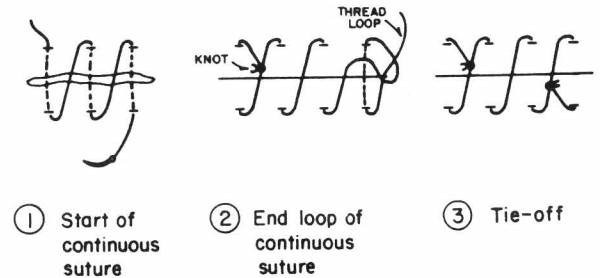

Fig. 52. Suturing a broodstock sturgeon following surgical examination.

A. CRUCIATE SUTURE



B. CONTINUOUS SUTURE



C. SINGLE SUTURE



Fig. 53. Suture patterns used to close incisions made during the surgical examination of sturgeon broodstock.

Reusable, plastic, cattle leg-band tags or similarly constructed tags are good for short-term tagging of larger broodstock. The tag is placed around the caudal peduncle with just enough slack to avoid constriction or chafing of the flesh (fig. 54). Tags left on the fish for long periods or applied too tight usually result in irritation that causes swelling of the caudal peduncle and profound damage to the tail tissue.

Spaghetti tags, although harder to read without removing the fish from the tank, cause minimum damage and are more suitable for long-term holding. Two tags are used to reduce the chance of lost data if one becomes dislodged. The spaghetti tags are lodged into the shoulder muscle of the sturgeon with a tag gun. This instrument has a thin notched knife that punctures the flesh and slides an anchor into the flesh when the instrument is squeezed. The tag gun delivers a series of numbered tags that are held on a sliding bar (fig. 55). In addition to the tag number, different colors may be used to identify males and females or fish in different stages of maturity. Spaghetti tags work well with both large and small broodfish. Other tagging and banding techniques may be applicable, but their application and suitability have not been well tested in long-term holding of sturgeon.

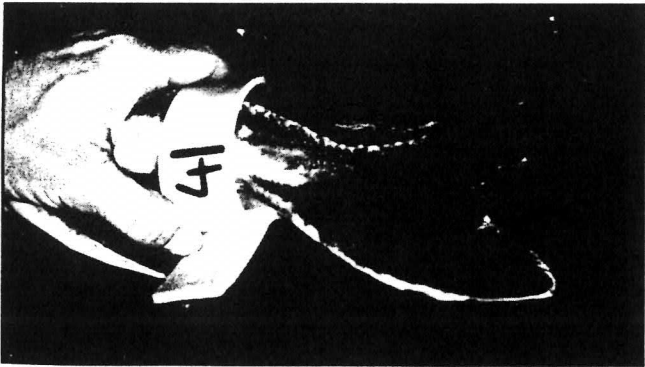

Fig. 54. Cattle leg-band used to tag sturgeon broodstock.

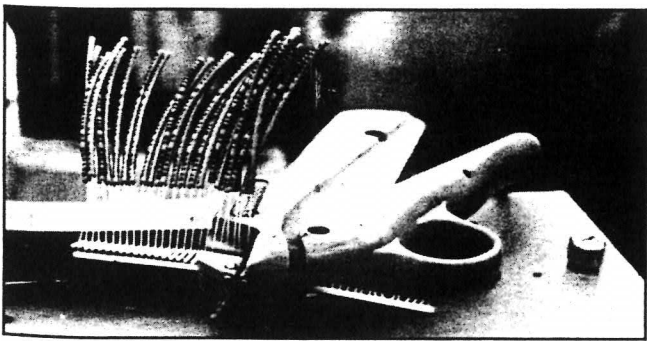

Fig. 55. Tagging instrument with numbered spaghetti tags used to tag sturgeon broodstock.

Determination of Potential Spawners: Optional Test

Potential spawners are determined by examining GV position in oocyte samples taken during primary broodstock examination. The method is based on oocyte maturation and is a modification of the procedures developed by Detlaf and Ginzburg (1954) and Detlaf, et al. (1981). Five to 10 of the sampled oocytes are poured into a 150-ml beaker containing hatchery water or Leibovitz incubation medium, placed on a hot plate, and boiled for five to eight minutes. This hardens the yolk and fixes the position of the nucleus or GV. The sample is then cooled by placing the beaker containing the sample in a tray with crushed ice (figs. 56 and 57).

To determine GV position, the oocyte is bisected and examined under a dissecting microscope. This procedure is accomplished by grasping the oocyte with a pair of Adson-Brown tissue forceps and making a cut along the animal-vegetal axis (fig. 58). The cut can be made with a surgical scalpel or a single-edged razor blade. The position of the GV can then be observed and evaluated (table 6 and figs. 59 and 60).

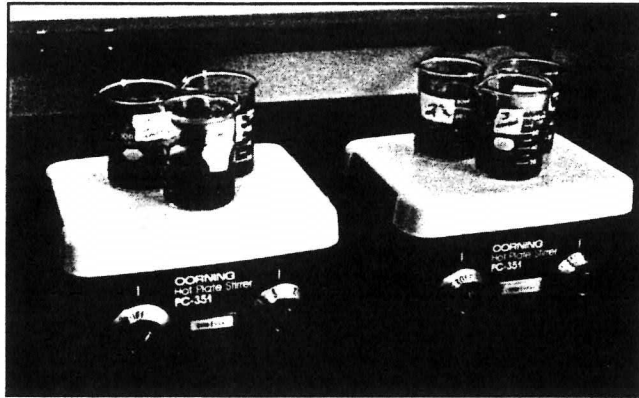

Fig. 56. Sturgeon oocyte samples in beakers containing Leibovitz incubation medium boiling on hot plates.

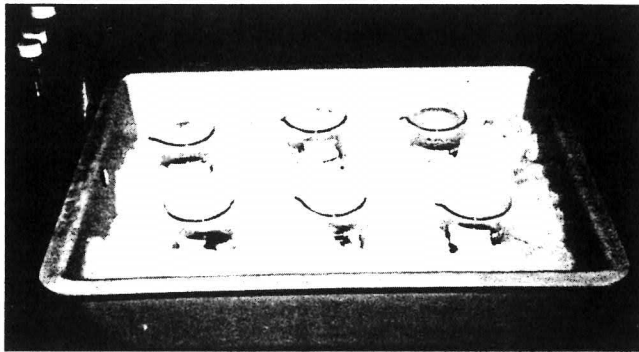

Fig. 57. Sturgeon oocyte samples chilled on ice in beakers containing Leibovitz incubation medium.

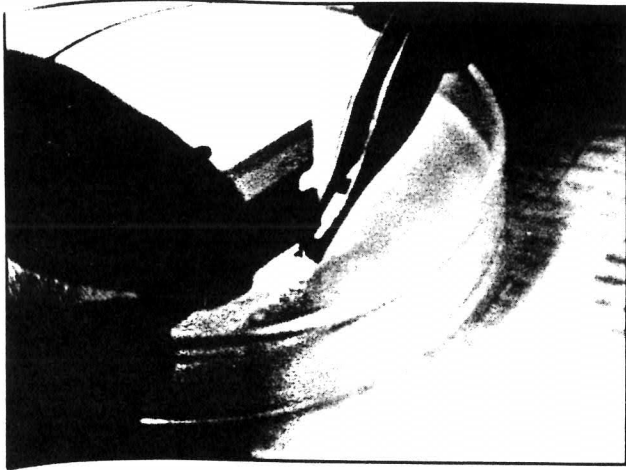

Fig. 59. Bisecting a single white sturgeon oocyte along the animal-vegetal axis to determine the position of the germinal vesicle (GV).

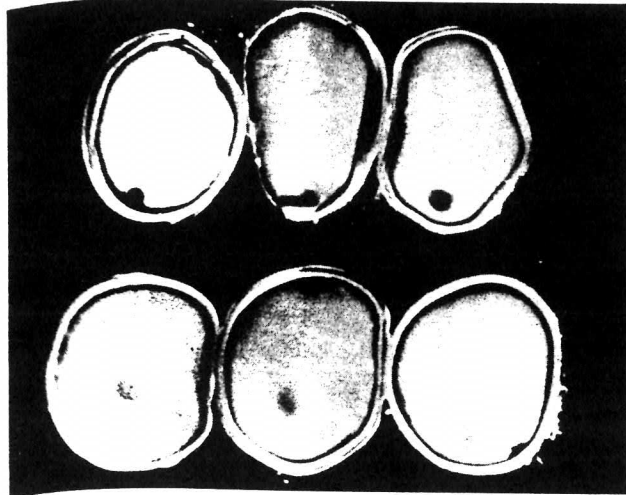
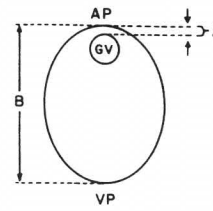

Fig. 60. Six bisected white sturgeon oocyte samples used to determine the position of the germinal vesicle (GV). The GV is seen in each sample as a dark sphere or smear in the ooplasm or near the internal margin of the oocyte.

Classification of late-stage maturity of oocytes based on oocyte polarization and germinal vesicle migration*

Description
Oocytes are round, 3.0-3.5 mm in diameter, GV† is centrally located.
Oocytes are ovoid, 3.5-3.8 mm in diameter, GV has moved toward the animal pole and is located approximately half the distance between the oocyte center and cortex.
Oocytes are ovoid and "pointed" at the animal pole, 3.8-4.0 mm in diameter, large GV lies in the cortical ooplasm of the animal pole.

* Dotschov, et al., 1983.
† Germinal vesicle.



AP = Animal Pole A = Distance between GV and cell membrane
 VP = Vegetal Pole B = Diameter of oocyte along animal-vegetal axis
 GV = Germinal Vesicle Q = Classification index
 $Q = \frac{A}{B}$

Fish that are good candidates to spawn in the regular spawning season are in stage IVc; Q should be less than 1/14 or 0.07.

Fig. 60. Diagram of a sturgeon oocyte showing the position of the germinal vesicle (GV) in the cortical ooplasm of the animal pole and formula for determining stage. (Modified from Dettlaf et al., 1981)

Oocytes in stage IVa are underdeveloped and will not respond adequately to spawning induction. Oocytes in stage IVb are questionable, and spawning induction should be at the discretion of the hatchery manager. Oocytes in IVc are the most ripe, and females are good candidates for induced spawning. The position of the GV does not vary greatly in individual eggs from a sample, and sectioning of 5 to 10 eggs is usually adequate.

The timing for making the determination of potential spawners among broodstock taken from nonspawning areas can vary. Some hatchery operators elect to postpone the determination until the animals are transported to the hatchery. Others elect to hold the animals in the hatchery until the peak of the natural spawning season, then perform the analysis on the day before spawning induction is scheduled.

Broodstock captured in nonspawning areas are allowed to recover before they are transported to the hatchery, where the maturation process is continued. Anadromous species captured in salt water are first taken to an acclimation facility, where they are placed in tanks, acclimated to freshwater, and then moved to the hatchery for the maturation process. White sturgeon have been successfully acclimated from 35.0 parts per thousand salinity to freshwater without disrupting the maturation process. After capture the fish are held in an acclimation tank for 24 hours in flowing water of the same salinity as that of the capture site. The salinity is rapidly reduced to 15.0 parts per thousand within 2 to 3 hours. Over the next 12 to 24 hours, water salinity is gradually

reduced to freshwater, and the fish are held in freshwater for a minimum of 6 hours before transportation to the hatchery.

Field Evaluation: Broodstock from Spawning Areas

Sturgeon taken from spawning areas and exhibiting secondary signs, such as an enlarged, soft abdomen in females and flowing milt in males, should be transported to the hatchery as soon as possible. Sturgeon milt and eggs have been obtained from ripe animals in the field and later fertilized, but for maximum efficiency the full resources of the hatchery should be used. During

transport of female sturgeon broodstock a gradual and slight rise in temperature can be tolerated, but a drop in water temperature often results in a poor or aborted spawn.

In response to the stress of capture, ripe females near spawning may undergo physiological changes precluding or reducing the chance for successful ovulation. To prevent this consequence, some hatchery operators administer the initial injection of inducing hormone at the capture site prior to transport to the hatchery (see "Spawning Induction of Broodstock," page 47). Other hatchery personnel prefer to immediately move the animal to the hatchery, especially if the transport time is short.

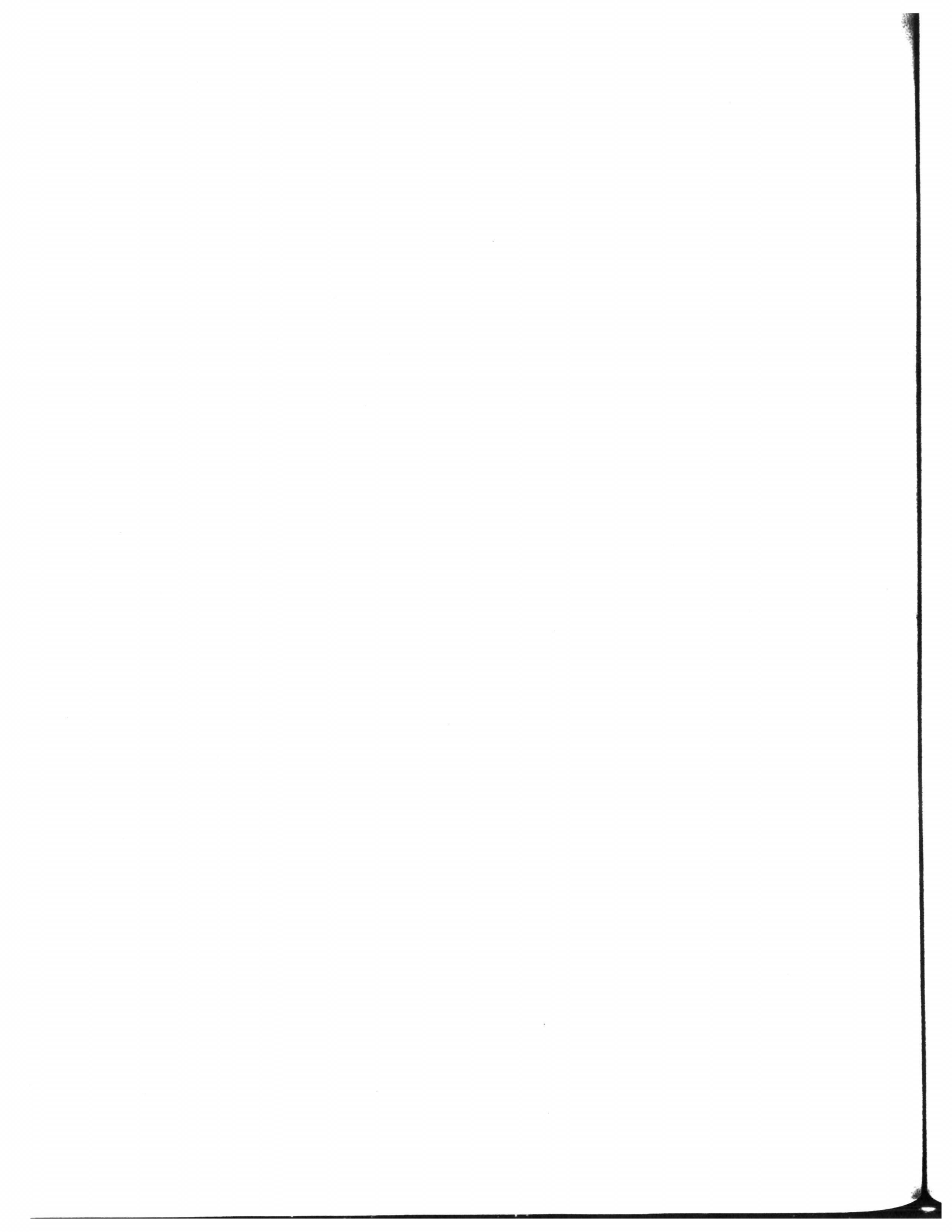

SECTION VII

Broodstock Evaluation: Hatchery

Overview

Sturgeon hatcheries may deal with three types of broodstock: (1) wild-caught, nonripe animals that require holding and further maturation; (2) wild-caught, ripe animals that are close to spawning; and (3) juvenile, hatchery-reared animals that are being developed as future broodstock. In this section we address ripe and nonripe wild-caught animals and the techniques used to produce fry from these sturgeon. Juvenile, hatchery-reared animals being held for future broodstock may be grown in tanks or earthen ponds and biopsied as they approach maturity.

Nonripe Broodstock

Nonripe broodstock are wild-caught adult sturgeon that were captured prior to the completion of vitellogenesis and oocyte polarization, events that precede ovulation. This category can include anadromous or freshwater species captured prior to or during the reproductive migration, but does not include ripe females captured on the spawning grounds. These fish are brought into the hatchery, maintained, and monitored for sexual development. Those exhibiting gonadal maturity are induced to spawn.

A significant percentage (30%-40%) of the females selected during the primary field examination and held at the hatchery for further development may not progress to the ripe stage because of capture stress resulting in physiologic changes that preclude successful spawning. For this reason, immediately before an animal is chosen for spawning induction a second, more detailed surgical examination is performed to determine egg condition.

Maturation Tanks

When nonripe sturgeon broodstock arrive at the hatchery they are transferred to long-term holding tanks. The sexes are usually kept separate. This is not required, but is more convenient when the animals are examined later. These animals may have to be maintained for up to 5 months, depending on time of capture and the spawning season for the species.

Captive feeding of wild-caught sturgeon has been reported. Sturgeon have been enticed to feed on lamprey and salmon flesh at the Bonneville, Oregon salmon hatchery. In general, however,

wild-caught sturgeon do not feed actively in captivity, and any feeding attempts should be closely monitored to avoid tank contamination by uneaten food. Unripe white sturgeon have matured and been induced to spawn in captivity after being held 4 months in tanks without food.

Establishing Dates for Final Selection and Spawning

Spawning times of natural populations of North American sturgeon vary according to species, latitude, and local conditions (table 1). Hatchery personnel schedule the final examination of broodstock and spawning induction to match the natural spawning season of the selected species, and spawning induction is usually timed to occur in the middle of its period. The final selection of females for spawning induction is made 1 day before to the desired spawning date and is based on the physiological *in vitro* test of oocyte maturation (GV breakdown).

If potential spawners have not been determined using methods to classify stage IV oocytes (table 6), both this test and the assay to select animals for induction, as described below, may be run simultaneously using the same oocyte samples. To do so, double the oocyte sample and follow the procedures for classifying stage IV oocytes, as described earlier, and for identifying GV breakdown, as described below.

Final Female Selection: Preassay Surgery

The final selection of females to undergo spawning induction is made once the oocyte samples are surgically removed, incubated in a medium containing the maturation-inducing steroid progesterone, and examined for the specific maturation response, that of GV breakdown (for an explanation of oocyte maturation, see Appendix 12). To accomplish this selection process, a female sturgeon is removed from the holding tank with a tube net, transported to the examination area, and anesthetized with MS-222. The sturgeon are placed in a temporary holding tank containing aerated water with 100 to 150 ppm MS-222. When the fish are subdued, they are transported to the surgery area by stretcher. The surgery area is equipped with two water hoses used to flush the sturgeon's gills. One hose delivers freshwater and the other delivers water from a recirculating sump containing aerated water with 75.0 ppm MS-222. For a list of

equipment used for hatchery examination of sturgeon broodstock, see table 7.

During surgery the hoses are exchanged, the timing of which is based on the judgment of the person conducting the surgery and the criteria described in table 5. During the exchange the stretcher is repositioned on the notched sawhorses to allow the overflow of freshwater to be discharged out of the area or the overflow of the MS-222 water to be returned to the sump. If many fish are being examined in one day, a fresh sump solution of MS-222 is prepared at midday. The water should have a minimum oxygen concentration of 5.0 mg L and temperature and pH comparable to the water in the source holding tank. The watertube system is then set up. The surgical equipment, disinfectant, and incubation materials are prepared in advance and positioned next to the person making the examination (for a list of equipment needed, see Appendix 13).

Before surgery, the abdomen is washed with 4.0 percent nitrofurazone. A 0.5 cm incision is made through the body wall in the ventral midline, three to five ventral scutes anterior to the genital pore. The incision is usually made slightly above or below the cut that was made during the original fish examination.

When present, the oocytes appear as a mass of darkly pigmented spheres with a diameter between 3.4 and 4.2 mm. Approximately 50 oocytes are removed from the sturgeon by aspiration using a length of tygon tubing and following the methods described in the surgical examination of sturgeon from nonspawning areas (pages 38-39).

TABLE 7. Equipment used for hatchery examination of sturgeon broodstock

Hooded stretcher	Stretcher rack
Watertube	Watertube circulation pump
Watertube sump	Wash bottle with 4% nitrofurazone
Razor blades	Scalpels with #10 and #15 blades
Forceps, suture needle	Forceps, common, straight, and curved
Forceps, Adson-Brown tissue	Hemostats, straight and curved
4.0-5.0 mm tygon tubing	Sample vials, 50 or 100 ml
Ground glass tissue homogenizer	Leibovitz L-15 incubation medium
Identification tags	Record book
Tape measure	Scale
150-ml beakers	Hot plate
Dissecting microscope	Shallow tray, 12" x 24"
Crushed ice	Paper towels
Disposable petri plates	Refrigeration unit
Balance	
Formalin, 4.0% filtered solution	
Monofilament suture material swaged to half-circle surgical needles 23-25 gauge, 3.2-cm long needles with transparent hub	
1.0-3.0 cc plastic disposable injection syringes	
Sterile distilled water or 6% physiological saline	
Progesterone maturation steroid stock solution	
Thiodoethylene	
Induction hormone: Acetone-dried common carp pituitary gland powder LHRHa)	

TABLE 8. Level of sedation and corresponding response of sturgeon anesthetized with MS-222

Level	Response
1	After introduction of MS-222, opercular movement (ventilation) increases, and some abnormal swimming behavior may be apparent.
2	Rapid opercular movement decreases to below normal, swimming becomes slow, and fish exhibits some loss of equilibrium.
3	Fish exhibits slow opercular movement, slow swimming activity and, if turned over while swimming, is able to return to the upright position.
4	Fish exhibits slow and infrequent opercular movement. There is a complete loss of equilibrium, and the fish is unable to right itself when turned over.*
5	No opercular movement.†
6	Overextended opercula.‡

* Sturgeon are moved and surgery is performed at this stage.

† The fish should immediately be given fresh water containing no MS-222.

‡ The fish is in shock and will die if the gills are not immediately flushed with fresh water. Anesthetic should not be used again, and the fish should be allowed to recover.

Assay for Determining Spawning Females: Final Oocyte Maturation

The maturational steroid assay for determining spawning females involves incubating oocyte samples from selected females and examining the oocytes for the presence or absence of a nucleus, or GV. Absence of a GV after exposure to maturation-inducing steroids is termed germinal vesicle breakdown (GVBD). The presence and percentage of GVBD in the oocytes examined indicates sturgeon suitable for spawning induction.

Approximately 50 oocytes are removed from each female, placed in a marked container of chilled (16°) Leibovitz incubation medium, and held in a bed of crushed ice. Twenty-five oocytes from each sample are added to pre-labeled, disposable petri dishes or tissue culture plates filled with 20.0 ml of the incubation medium. Care is taken not to add additional volume of Leibovitz incubation media to the plates when transferring the oocytes. Then 0.2 ml of predissolved progesterone maturation steroid stock solution is added to each culture plate and gently mixed (fig. 61). For preparation of stock solution, see Appendix 14. The progesterone hormone is used to stimulate egg maturation. The final concentration of each dish is 10.0 micrograms of progesterone per milliliter of solution. The plates containing the oocyte samples are then allowed to incubate for 24 hours at 15° to 16°C. Agitation and special atmosphere are not required.

At the end of the incubation period the contents of the plates are poured into 150-ml beakers, boiled for 5 to 8 minutes, and cooled in crushed

ice. A portion of each sample may be fixed in 4.0 percent buffered formalin if egg records are to be kept. The oocytes are then bisected along the animal-vegetal axis and examined for GVBD. The boiling, cooling, and cutting technique is identical to that used on oocytes in Section VI, "Determination of Potential Spawners: Optional Test," pages 41-42. If no GV is apparent, additional cuts are made away from the exposed edge in both sections to eliminate error due to an incorrect cut or slightly off-center nucleus. Normally, suitable preovulatory females exhibit GVBD in oocytes at a frequency ranging between 80 and 100 percent. Nonripe females exhibit GVBD at a range between 0 and 10 percent. Oocytes exhibiting GVBD at a range of 30 to 70 percent are relatively rare.

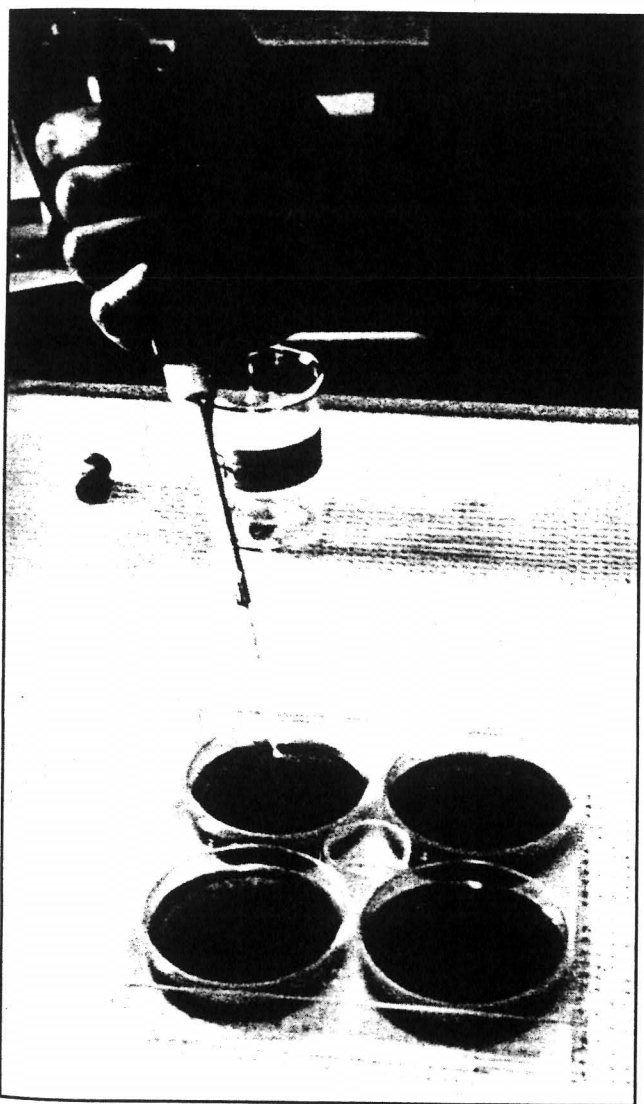

Fig. 61. Adding predissolved progesterone maturation steroid stock solution to culture plates containing sturgeon oocytes and Leibovitz incubation medium.

Spawning Induction of Broodstock

The previous discussion relates only to female sturgeon caught in nonspawning areas. The following information pertaining to spawning induction applies equally to females captured in both nonspawning areas and on the spawning ground.

To spawn sturgeon successfully in captivity, the broodstock are induced to ovulate (females) or spermiate (males) with exogenous hormone injections. Two types of hormones are commonly used in North America: acetone-dried common carp pituitary (CCP), gland powder and mammalian gonadotropin (or luteinizing hormone) releasing hormone analogue, D-Ala⁶, Des Gly¹⁰ Ethylamide, hereafter referred to as LHRHa. The more common of the two is CCP (for notes on the other exogenous hormones, see Appendix 15).

Injection Schedule

Spawning induction includes two injections of the selected hormone preparation. The initial, primary, injection is separated from the second, or resolving, injection by 12 hours. Ovulation can be expected within 20 to 40 hours after administration of the resolving injection. Variation in response depends on factors such as the size, age, and condition of the fish.

The timing of the injection is based on the animal's condition or the selected hatchery schedule. Ripe animals collected in the spawning area that are obviously near ovulation should be treated immediately. Animals in this condition are administered the initial dose in the field to prevent a negative spawning induction response often brought about by the stress of capture. For the convenience of daytime spawning, the second injection is usually given between 9 and 11 a.m. Ovulation and spawning are then anticipated during the morning hours of the following day. Ovulation in larger females may not occur until the late afternoon.

Induction Hormones

The amount of injected hormone is based directly on the sturgeon's weight, which may be taken using a modified stretcher sling hung from a scale or a holding frame mounted on a platform scale that receives the sturgeon stretcher. Based on the total weight of the fish, the dosage of CCP can be calculated from table 9 (for dosage and procedures using other exogenous hormones, see Appendix 16).

The acetone-dried CCP is prepared by mixing the powder form in a carrier solution of 0.6 percent physiological saline. A convenient method is to use an analytical balance to preweigh the CCP into 10, 20, 50, and 100 mg units and place these

units in capped vials. The capped vials are then refrigerated.

When the appropriate dose is determined, these pre-weighed vials can be combined to give the total amount required within ± 10.0 mg. Because stocks of CCP are not in standard concentrations, the ± 10.0 mg error is provided for in the formula for determining total dose.

The CCP powder is then placed into a ground glass tissue homogenizer and mixed with the minimum amount of saline carrier solution (0.3 to 0.5 ml) necessary to obtain a uniform solution. The homogenizer facilitates the release of maturation-inducing substance and breaks up the larger particles that could clog the injection syringe needle. If a large amount of CCP is used and the suspension is too dense, an additional 0.3 to 0.5 ml of physiological saline is added. The suspension is then allowed to settle in the homogenizer tube for 1 to 5 minutes before being collected by syringe. This preparation is made just before injection, because once in solution the hormone has a relatively short shelf life (± 1 hour) at room temperatures up to about 27°C. Shelf life may be extended for several hours if the syringes are kept on ice or in a refrigerator.

Thyroxine (triiodothyronine or T-3, Sigma Co.) is recommended by Detlaf, et al. (1981) to improve ovulatory success, especially for females that were subjected to thermal stress or held in the hatchery without food for a long period. It is hypothesized that the use of this hormone prior to the injection of the inducing hormone enhances the capacity of the follicle to respond to the inducing hormone with the secretion of maturation steroid hormone. The T-3 suspension is prepared by weighing out 100 mg of the substance per kilogram (4.5 mg/lb) of body weight for each selected broodfish (male and female) and adding this and no more than 1.0 ml of physiological saline to a capped vial. The contents are shaken, drawn into a syringe, and immediately injected into the fish.

Injection Procedures

Hormone injections are usually given with a 1.0 to 3.0 cc plastic disposable syringe fitted with a 23 to 25 gauge, to 3.2 cm long needle with a transparent plastic hub. If a series of fish are to be induced to spawn, the appropriate dosage is placed in the syringes and each syringe is labeled according to the targeted fish.

Injections are administered in the muscle between the lateral and dorsal scutes within the area extending from the base of the pectoral fin to the midsection of the fish (fig. 62). No more than 1.0 cc of solution should be administered at any one injection; several smaller injections on both sides

TABLE 9. Dose for exogenous hormone common carp pituitary (CCP) to induce spawning in white sturgeon*

	Females†	Males‡
Total Dose	4.0 mg/kg (1.8 mg/lb)	1.0 mg/kg (0.45 mg/lb)

* CCP = acetone-dried common carp pituitary powder.

† Total dose for female is divided into two injections with initial dose = 10% of total dose.

‡ Total dose for males is given in one injection 2-6 hours before the females' resolving dose.

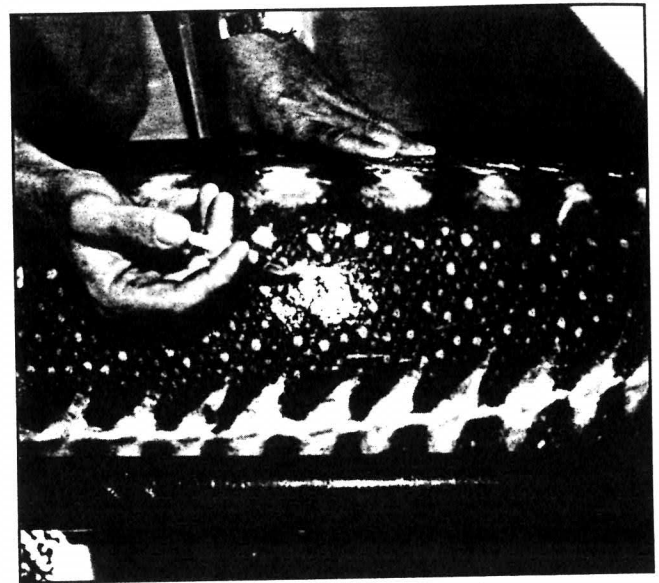

Fig. 62. Injecting sturgeon broodstock with spawning-induction hormone.

of the body of larger fish are recommended if the dosage exceeds this amount. The injection is made in the thicker part of the dorsal muscle, approximately 1/3 distance of body length from the head, between the lateral and dorsal scute rows.

For fish larger than 12 to 15 kg, the injection should be made with the syringe held perpendicular to the fish's body. The needle should be inserted at an angle only in smaller fish with less muscle mass in the injection area. As the needle is withdrawn, a finger is placed over the puncture for a few seconds to prevent backpressure from expelling the injected solution. The injection site is then massaged. Females should spawn within 20 to 32 hours after the resolving dose. The latency period (time from resolving injection to ovulation) will depend on water temperature and the body size of the fish. Lower temperature and larger body size will increase the period of latency. Males molt within the same relative time frame.

Several methods have been employed to administer hormone injections to sturgeon. They have been injected while being held in a tube net

or in a stretcher placed under the fish to partially elevate it out of the water. Sturgeon have also been injected underwater while resting passively on the bottom of the spawning tank. The choice is usually based on the skills of the hatchery operator. Less experienced personnel may forcibly restrain the fish with a tube net or stretcher, but this action may agitate and stress large sturgeon during a critical period. Broodfish have been known to jump out of the spawning tank while being restrained in this way.

Underwater injections are often used. The advantages of this method are that it requires only a single person to administer the injection, and it eliminates the stress caused by forcible restraint. It requires certain skill and patience to approach the sturgeon and administer an underwater injection, but a sturgeon can be very docile under these circumstances. The fish may move slightly or even swim slowly away, but with patience and a steady hand the injection can be given quickly and easily, with a minimum disturbance.

Male Response

The only visible evidence that a male sturgeon is preparing to milt may be cloudiness of the tank's water caused by the release of a small amount of sperm. If cloudiness is not readily apparent within the expected time frame, the animal may be further checked to determine when the milt is ready to be extracted. Checking is done by restraining the male in a tube net, rolling it over onto its back, and palpating the urogenital area. The male fish may be active during the examination, but concern for unnecessary stress in males is not as critical at this stage as it is in females. If the male responds normally, he should begin to milt ± 20 hours postinjection in water temperatures of 14° to 17°C and palpation is usually not necessary. Care is taken not to express too much milt during palpation, to avoid wasting quantities needed during fertilization.

Female Response

Ovulation can be expected within 20 to 40 hours after administration of the resolving hormone dose. The timing of the injection is at the discretion of hatchery personnel. Although sturgeon have been induced to spawn at all hours in the 24-hour cycle, the ovulatory response is observed more frequently in either the early morning hours or the late afternoon and evening hours. Regardless of the timing, prespawning preparation requires about an hour, and female sturgeon should be checked regularly starting at least 6 hours before their predicted spawning time. This inspection is necessary to avoid loss of eggs from an early induction response and spawn.

The first indication of a spawning/ovulation response is the appearance of several eggs stuck to the bottom or sides of the tank. If the egg check is made at night, examination with a flashlight may be necessary. It is essential to check the released eggs at this time to determine if they feel sticky. The stickiness results from a swelling of egg jelly that hydrates on contact with water and secretion of the adhesive substance. In this condition the eggs will adhere to almost any surface.

If the released eggs are not sticky, the female has released eggs prematurely and should not be taken from the tank for egg removal. Sometimes a female will release a few nonsticky eggs followed by the release of a few hundred sticky eggs, in which case the spawn is usually a success.

The release of nonsticky eggs indicates potential problems. If this continues well past the predicted period of spawning, chances of a successful spawn are diminished. If a few nonsticky eggs are released initially and then no eggs are released for 5 to 8 hours past the predicted spawning period, the female usually will not ovulate properly or produce viable eggs. If she does not release the eggs, they will be reabsorbed over a period of time. In addition, the eggs that are released will show, at best, a low rate of fertilization and development.

SECTION VIII

Gamete Processing

Preparation of Materials for Egg De-Adhesion

De-adhesion of fertilized sturgeon eggs is critical to successful hatchery rearing of the fish, and the materials must be prepared well in advance of egg fertilization. A list of materials to be used in all gamete processing appears in table 10. Two methods are used for the de-adhesion of fertilized sturgeon eggs in North American hatcheries:

1. Occlusion of the sticky surface of fertilized eggs with river silt
or
2. Chemical alteration of the sticky jelly coat, which eliminates the ability of fertilized eggs to adhere to other surfaces.

TABLE 10. Equipment used for gamete processing

Flashlight	Egg de-adhesion material
20-L (or 5-gallon) container	Plastic bags, 20-L (or 5-gallon)
5.0-8.0 cm tygon tubing	20-cc plastic syringes
60-cc plastic syringes	Pure oxygen source
Rubber bands	Glass containers, 250 ml
Paraffin sheet material	Compound microscope
50.0-ml sample vials	Grid slide and cover slips
Dropper	4" knife
3.0-5.0 L steel bowls	Rubber spatula
Small glass or plastic bowls	25.0 ml graduated cylinder
1,000-ml graduated cylinder	Large and small steel or plastic spoons

Silt

De-adhesion of fertilized sturgeon eggs with river silt is the most commonly used method. River silt substitutes, such as clays and even diatomaceous earth, have also been used. However, diatomaceous earth often abrades the eggs and increases egg mortality. Because the silt is used liberally in the de-adhesion process, a large amount is prepared beforehand so excess is available when it is needed. Approximately 23 kg (50 lb) of the dry silt material is prepared in advance and stored in plastic bags to be available at the hatchery at all times.

Silt is prepared by collecting river or stream-bottom sediment from a spawning area or from another location with similar silt conditions. Care should be taken to avoid areas with known toxic chemical residues. If dry sediment is collected, it

is mixed with water, and after 1 minute the supernate is poured into another container. This step removes large particles and fine sand from the silt suspension. The silt suspension is allowed to settle for about 2 hours, after which the supernate is poured off and the residue silt is dried. The dried silt is then broken up and passed through a sieve, such as a common window screen. The fine silt is baked at 260°C for 3 hours to burn off or kill organic matter, cooled, and stored in large plastic bags. For de-adhesion, several handfuls of dried silt are placed in a container and suspended in hatchery water at the temperature of the eggs to be fertilized.

Chemical De-adhesion

To chemically remove the jelly layer from fertilized sturgeon eggs, a treatment of urea and sodium chloride (NaCl) or sodium sulfide (Na₂SO₃) is used, followed by a tannic acid wash. This process is similar to the one employed for de-adhesion of common carp eggs. The advantages of chemical de-adhesion are that it is quick and the treatment does not introduce pathogens or environmental toxicants such as pesticides or heavy metals. The disadvantages are that a slight miscalculation in preparing the concentration of the chemicals can result in total egg loss and few hatcheries have experience using the technique. Because few data are available on the use of chemical de-adhesion in the hatchery, the process is outlined below. However, only the silting method of de-adhesion is recommended, and presented in the later portion of this section on egg fertilization.

Stock solutions of 0.4 percent urea, 0.3 percent NaCl, and 0.1 percent tannic acid are prepared in advance and adjusted to the hatchery water temperature. Fertilized eggs are treated with the solutions of urea and NaCl for 5 minutes, followed by a 1 minute wash with tannic acid. The 0.1 percent tannic acid is then partially decanted and diluted to a 1:1 ratio with freshwater. This step is repeated three times over a 3 minute period. The eggs are then washed three times in freshwater and prepared for incubation.

Milt Extraction Overview

Milt may be collected several hours before egg fertilization. To collect milt, the fish is held in a tube net with the vent exposed. The uro-genital area is dried with paper towels, and care is taken to pre-

1955 COMMERCIAL BUREAU BUREAU

vent contamination of the sperm with water as it is collected.

Milt is collected with a 5.0 cm length of tygon tubing attached to the nipple of a 20-cc plastic syringe. Initially, the plunger of the syringe is depressed. The tygon tubing is then inserted into the genital opening located just posterior to the anus (figs. 63, 64, and 65). Milt is collected by massaging the abdominal area over the testes to force milt into the collecting ducts and slowly withdrawing the plunger while moving the tubing back and forth in the genital opening. This technique will remove large quantities of milt without contamination by either feces or water.

Milt Storage

If not used immediately, sturgeon milt may be stored for up to 12 hours by refrigerating the collection syringes containing the sperm at 4°C. White sturgeon milt has been stored for up to 2 weeks and used successfully when maintained in a pure oxygen atmosphere in 20 to 60-cc plastic syringes refrigerated at 4°C (fig. 66). The oxygen atmosphere is added to the syringe by attaching the collection tube to a pure oxygen source and slowly withdrawing the plunger. The contents of the syringe are then agitated to assure maximum oxygenation and the tube clamped or plugged for storage. The oxygen should be replaced every 12 hours by expelling and replacing the old gas by the method described above.

An alternative storage method for milt is to place the milt samples in 250.0-ml glass containers embedded in a tray of crushed ice. The openings of the containers are covered with a paraffin sheet seal ("parafilm") and an "X" is cut into the seal to allow oxygen exchange. The tray containing the samples is enclosed in a large plastic bag inflated with pure oxygen, sealed, and stored at 2° to 5°C (figs. 67 and 68). For a discussion of cryopreservation of sperm, see Appendix 17.

The viability of stored sperm should always be checked before it is used, because there may be a slow but steady decrease in sperm viability during storage. Poor quality sperm will deteriorate even more rapidly when stored, so all milt samples should be evaluated immediately after collection. Milt samples destined for long-term storage should be of highest quality. Samples with less than 75 percent viability should not be stored for extended periods.

Checking Sperm Viability

Before sperm is used to fertilize eggs it should be examined with a microscope to determine viability. Viability is based on the ratio of activated to nonactivated sperm following water activation and before the sperm loses mobility. The deter-

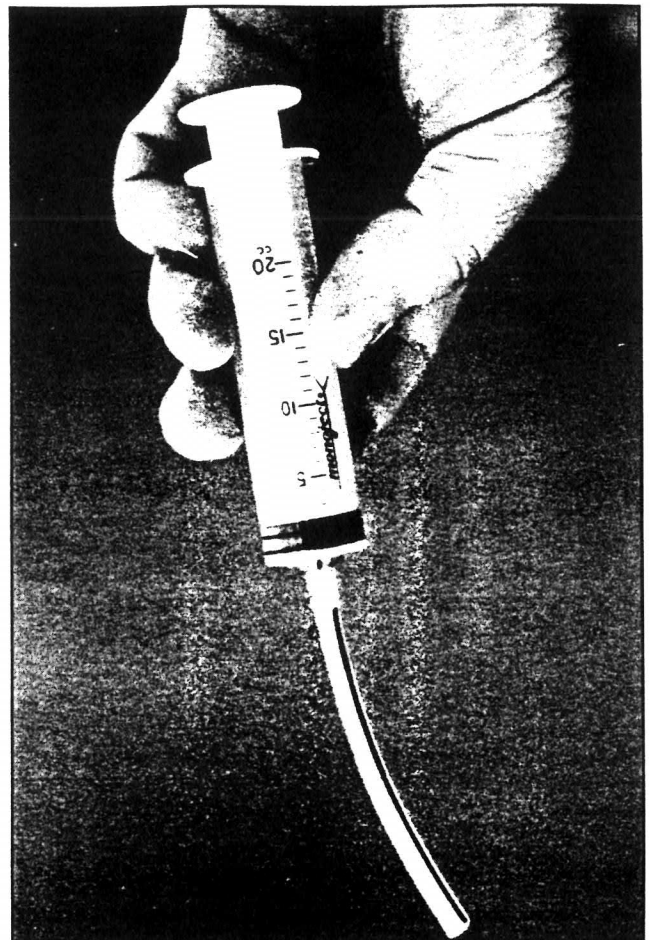

Fig. 63. Large syringe fitted with a piece of tygon tube used to remove milt from male sturgeon.

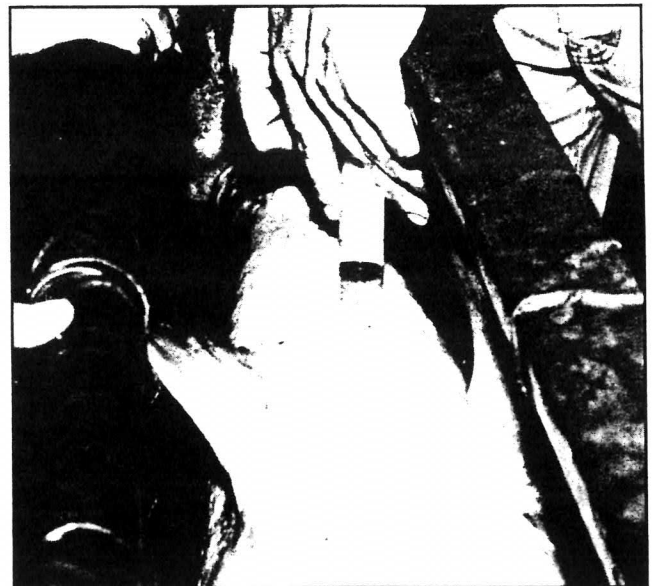

Fig. 64. Removing milt from a male sturgeon.

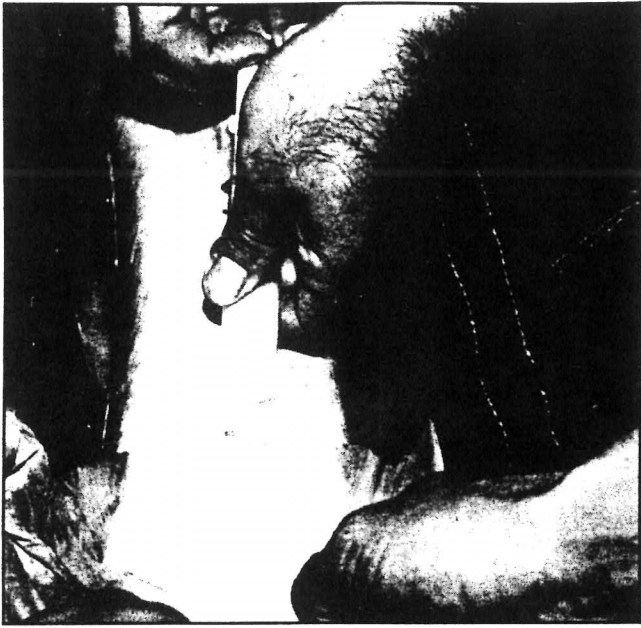

Fig. 65. Close view of use of syringe to remove milt from a male sturgeon.

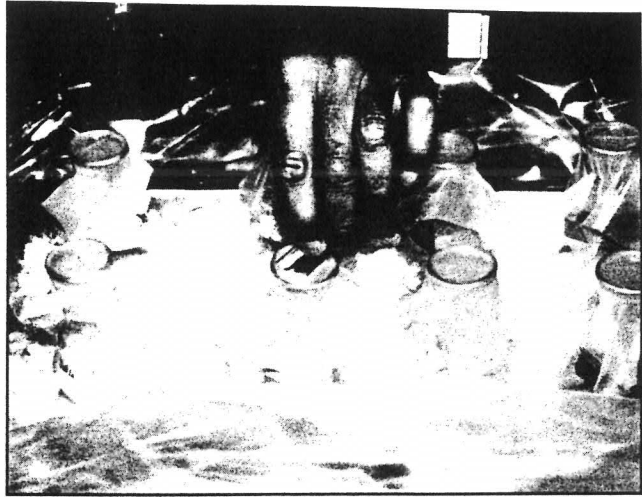

Fig. 67. Cutting an "X" in the paraffin seal to allow oxygen exchange in a container of sturgeon milt. The containers are embedded in a tray of ice for rapid chilling before storage at 4°C.

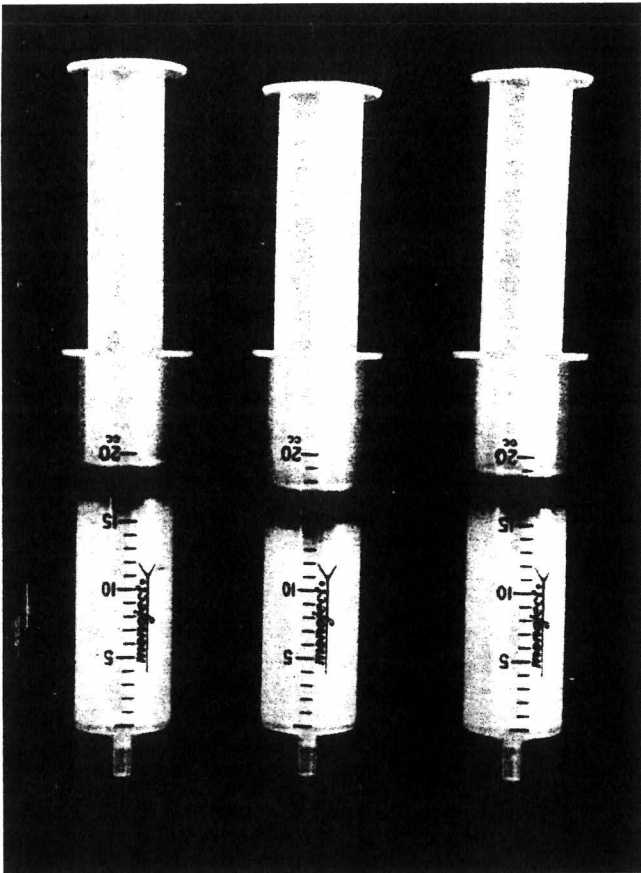

Fig. 66. Syringes containing sturgeon milt ready for storage at 4°C.

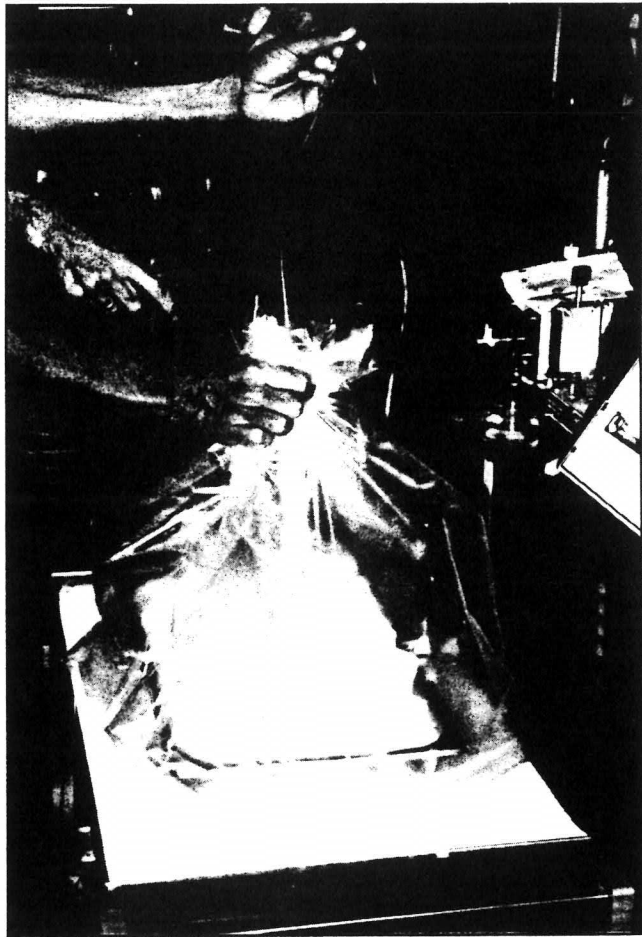

Fig. 68. Prior to storage at 4°C, the ice tray containing sturgeon milt samples is enclosed in a plastic bag that is inflated with pure oxygen and sealed.

mination is made in three steps: (1) estimate the ratio of motile to nonmotile sperm at 30 seconds; (2) record the time when 50 percent of the sperm show activity; and (3) record the time of relative cessation of sperm activity. If the milt has been stored under refrigeration or on ice, it should be warmed to about 10°C before being checked.

The viability of sturgeon sperm is evaluated by an estimation of sperm motility. This is done with a light microscope equipped with a stage illuminator, 20X objective lens and a grid slide with a cover slip. A small sample of semen (less than 1/100 ml) is placed on the cover slip with a Pasteur pipette. A small amount of aerated fresh water (0.2-0.3 ml) is placed on the grid slide and the cover slip containing the semen sample is gently pressed over the slide. The smear is immediately examined with the microscope for sperm motility.

The first determination is made by selecting a representative field of 10 sperm and recording the ratio of active to inactive sperm after 30 seconds. Next, scan counts within grids are taken until approximately 50 percent of the sperm are motile, and then the time is recorded. Finally, the time is recorded at which 80 to 90 percent of the sperm are immobile. Average counts using fresh, replicate samples are recommended.

Samples with average 30-second counts of at least seven to 10 active sperm are used for fertilization. The time of 50 percent motility is useful as an indication of when egg fertilization is losing momentum. The time of relative cessation of sperm activity indicates when sperm-egg mixing becomes ineffective.

Sperm Dilution

Sturgeon sperm have a relatively short viable period following water activation. Preparations are made for sperm dilution in advance of fertilization, but the actual dilution of sperm with water is not made until the moment of fertilization.

The milt used in fertilization should not be prepared until the eggs are taken and the post-fertilization protocol is fully prepared. Once activated, the sperm must be used within a few seconds.

During natural spawning the sperm released by the male is immediately diluted in the aquatic medium. This dilution must be mimicked in the hatchery to avoid problems such as inactivation of semen by coelomic fluid and polyspermy. Under normal circumstances, most sturgeon hatcheries use a 1:200 milt to water dilution. The density of sperm cells in the seminal fluids of injected males varies throughout the spawning season. The 1:200 dilution is a best estimate for representative

midseason males whose milt is similar in color to 2 percent low fat milk. The thin semen produced at the end of the spawning season or by males that have been spawned repeatedly is grayish-white and has the consistency of nonfat milk. The latter should be diluted with water in a ratio of 1:100. If semen is in short supply, the dilution can be increased to 1:500, or the 1:200 dilution can be used if the amount of water added to the eggs at the time of fertilization is reduced.

Milt samples are removed from storage and allowed to warm to the hatchery water temperature. The volumes of milt-to-water are determined to give the desired ratio, labeled, and kept separate until the moment before fertilization. The total volume of water and milt should be enough to cover the amount of eggs to be fertilized.

Egg Extraction Overview

To operate the sturgeon hatchery efficiently during egg processing, the hatchery must be prepared beforehand with all equipment ready and hatchery personnel given specific assignments. Egg extraction may be accomplished with two experienced people, but preparation of the eggs for incubation requires two more. More than four people in the work area during these activities can be a liability.

At this point a decision has to be made as to the ultimate fate of the female broodstock. The first option is to sacrifice the female and remove all the ova. This assures an efficient removal of eggs. A second option is to surgically remove the eggs by the methods described for sexing the fish and then return the sturgeon to the wild or to a broodstock holding facility. The latter option is preferable when handling an endangered or threatened species. However, hatchery production through female sacrifice has its place. In many instances, live sturgeon with viable eggs are legally captured in the commercial or sports fishery and offered to private or public hatcheries for fisheries enhancement as long as the carcass is returned to the donor. Therefore, both methods have value. Each method has prescribed steps described below to assure maximum success in obtaining viable eggs for fertilization.

Female Sacrificed

To kill the female sturgeon prior to egg removal, the fish is held in a tube net and administered a blow to the head. It is important to make sure beforehand that the fish is "nerve-dead" so that reflex nerve action will not cause muscle spasms during subsequent egg removal.

To remove the eggs, the fish is first hung on a hook by the mouth or gill opening so that the vent is at waist level to the person collecting the eggs (fig. 69). The tail is severed at the caudal peduncle, and the fish is bled to remove as much blood as possible. This step helps avoid or minimize contamination of eggs by blood from ovarian tissue that may affect egg quality. Blood is also believed to interfere with the sperm's ability to interact with the egg.

To remove the eggs, the abdomen of the sturgeon is cut with a knife, starting above the vent and continuing to the anterior of the abdominal cavity (fig. 70). A 3.0 to 5.0-L stainless steel bowl is held under the vent to catch the eggs. The bowl is held directly below the initial incision because gravity pulls the eggs out with considerable speed and force (fig. 71). The cut is made by inserting the point of the knife above the vent, with the blade facing outside, and carefully cutting just the abdominal wall as the incision is extended anteriorly (figs. 72, 73, and 74). Care is taken not to sever any internal organs or to slice through the egg mass. A second bowl is positioned under the first so that as the initial bowl fills, the second bowl can be moved into position without losing eggs. This process is repeated until the last eggs are taken.

During the process of egg removal not all the eggs will be free in the abdominal cavity. Often a substantial number of eggs will remain attached to the ovarian folds. If ovulation has been initiated, these eggs should be removed by gently combing them from the ovarian folds with your fingers and placing them in the fertilization bowls. The process of ovulation will be completed in the bowls within 15 to 20 minutes after removal from the fish, and high quality embryos can be obtained after fertilization.

Sometimes the last bowl or two of eggs will contain visible amounts of blood from ruptured ovarian tissue. Frequently, this blood interferes with fertilization of the eggs. Fertilization may be attempted with these eggs, but they should be placed in separate incubators and their development monitored closely.

Female Not Sacrificed

If the female is to be retained as future broodstock in the hatchery or in the wild, the eggs are removed surgically using techniques similar to those used in primary and secondary gonadal examination. The fish is positioned in a stretcher, ventral side up, with a watertube system employed. After the abdominal area is disinfected, an 8.0- to 10.0-cm incision is made near the previous incision and the egg mass exposed. Eggs are then gently removed with a large plastic spoon and placed in stainless

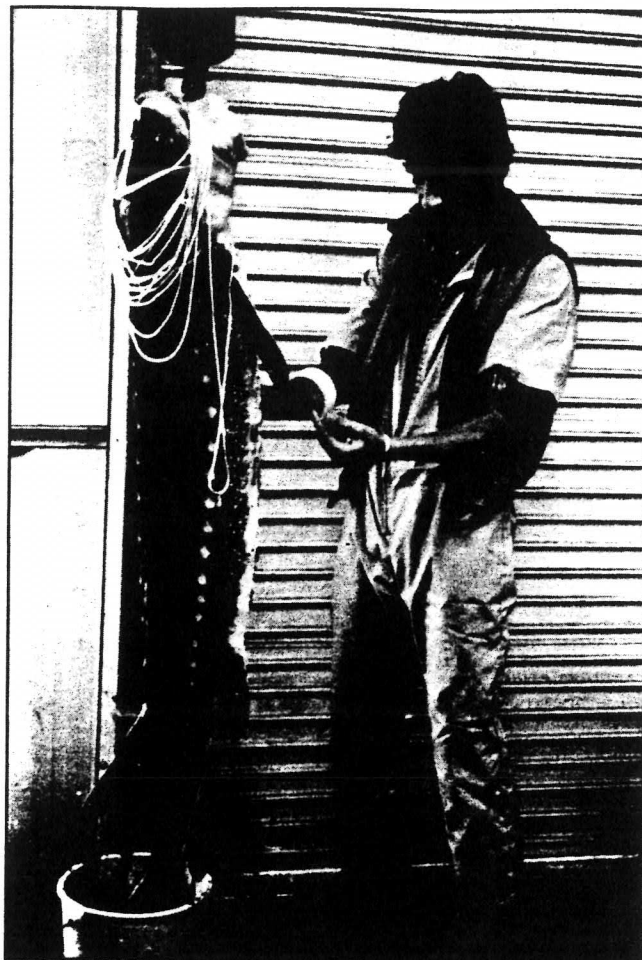

Fig. 69. Sacrificed female white sturgeon in preparation for egg removal.

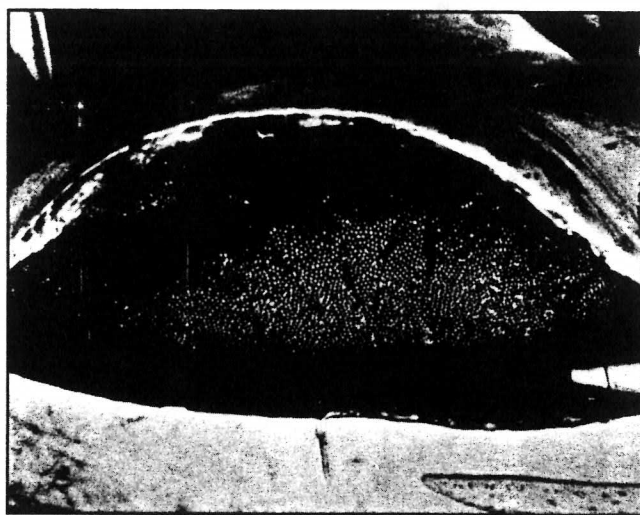

Fig. 70. A female paddlefish positioned on her back with belly cut to show the ovarian mass.



Fig. 71. Insertion of a knife point into the vent of a female sturgeon, with the cutting edge facing outside, begins the process of egg removal.

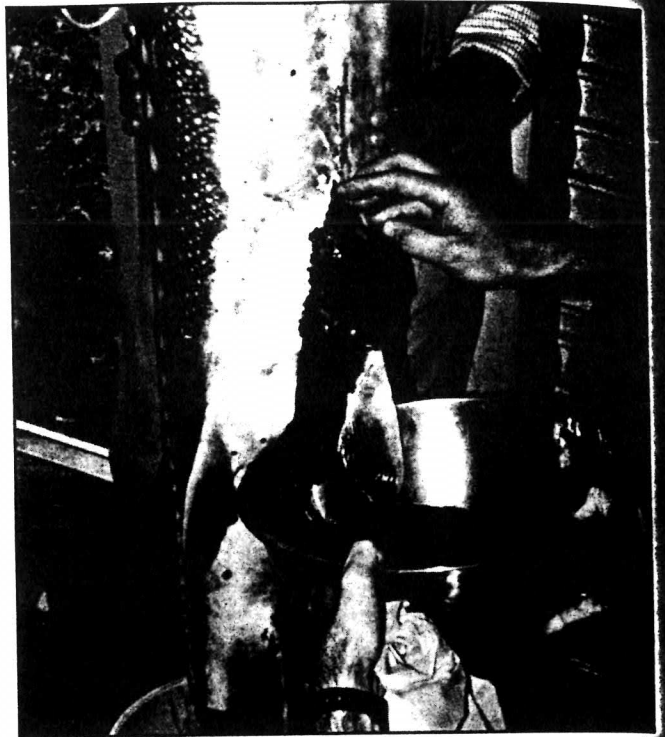

Fig. 73. Care is taken to assist removal of loose sturgeon eggs from the ovarian mass forced out of the cut by gravity.



Fig. 72. The cut is extended upwards while a bowl is positioned near the bottom to catch the eggs.



Fig. 74. The cut is extended to expose the total sturgeon egg mass. All loose eggs are carefully hand-combed from the ovarian mass and body cavity.

steel or plastic spoon and placed in stainless steel bowls (figs. 75 and 76). Since it is essential to avoid injury to the internal organs, only eggs easily reached are taken. This restriction may mean that only 30 percent of the eggs are removed. However, if ovulation is complete, 90 percent or more of the eggs can be taken. After the eggs are removed, the incision is sutured and disinfected by techniques described earlier under gonadal examination. The fish is then returned to the maturation tank for recovery.



Fig. 75. Surgery for egg removal being performed on a live female white sturgeon to be retained for broodstock.



Fig. 76. Eggs being spooned out of a live female white sturgeon. Later the female will be sutured and allowed to recover in a holding tank.

Egg Fertilization

Before fertilization is attempted, the material used in the egg de-adhesion process must be prepared and easily accessible. Instructions for preparation of the silt suspension appeared earlier in this section under the heading "Preparation of Materials for Egg De-Adhesion." They should be read before fertilization is attempted. If chemical de-adhesion is used, the stock solution should be at 14° to 16°C and readily available.

In preparation for egg fertilization, the bowl containing the eggs is tilted and excess coelomic fluid surrounding the eggs is poured off. Failure to remove the fluid can interfere with fertilization because sturgeon sperm are not motile in coelomic fluid.

The eggs are fertilized by adding the diluted milt solution directly to the bowls containing the eggs (fig. 77). The mixture is slowly stirred by hand. The mixing is continued for up to 3 minutes, or until the first few sticky eggs are noticed. At this time excess liquid is poured off and the de-adhesion process started immediately. The aqueous sperm solution will not interfere with the de-adhesion process.

The rapidity of the jelly-induced sticky reaction varies among egg batches. The variation may depend on factors such as water temperature, the time of the spawning season, or variations among individual females. In most cases the reaction is slow enough initially to give sufficient warning of the onset of the sticky reaction. The warning, however, may be as little as 60 seconds, and to assure egg survival the de-adhesion process should begin immediately.

Egg De-Adhesion

The preparation of de-adhesion material must be performed before the eggs are fertilized. If silt is used, several handfuls of dried silt are placed in a 19.0 L container. The container is filled with hatchery water at a temperature as close as possible to the temperature of the eggs, usually about 14° to 16°C. Silt is added to the water until a suspension is formed and a residue of silt accumulates in the bottom of the container.

To initiate the de-adhesion process, the silt suspension is poured into the fertilization bowl containing the fertilized eggs in a proportion of 2 to 4 volumes of silt to one volume of eggs. The mixture is then stirred gently by hand so the hatchery operator has a "feel" for the de-adhesion process. If any clumping of the eggs to the walls of the bowl has occurred, the clumps are gently broken up by hand (fig. 78). The silt suspension in the bowl should be changed every 10 minutes to maintain proper temperature and oxygen levels. To change



Fig. 77. Fertilization of sturgeon eggs by adding diluted milt to a bowl of eggs and slowly mixing with a soft instrument or by hand.

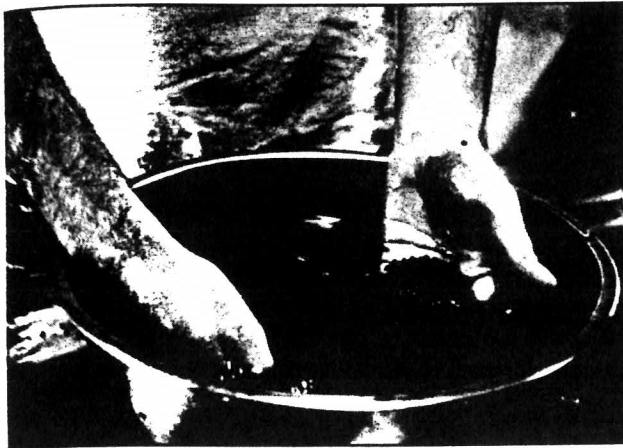

Fig. 78. Fertilized sturgeon eggs undergoing de-adhesion by hand-mixing with river silt.

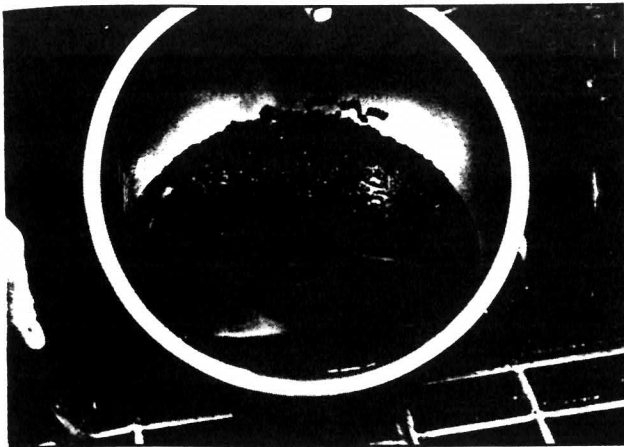

Fig. 79. Pouring off the suspension of river silt during de-adhesion of sturgeon eggs.

the silt suspension, the bowl of eggs is tilted, the suspension is poured off, and fresh silt suspension is added (figs. 79 and 80). The de-adhesion process is continued until the eggs do not stick to fingers or to one another when lifted from the bowl.

The time and labor required for silt de-adhesion depends on the water temperature. At least 20 minutes is required at water temperatures of 17°C and above, while up to an hour may be required at temperatures below 13°C. Individual batches of eggs will vary in their response to the de-adhesion process.

At the end of the process the eggs will have lost all stickiness. The bowl containing the eggs is then flushed with hatchery water until the water runs clear. The eggs will exhibit a fine coating of silt, especially around the vegetal pole, but most of the silt coat will eventually be lost in the incubation process (for mechanical siltation, see Appendix 18).

Measuring Total Spawn

After de-adhesion the eggs are counted by volume. This count is done by filling a 25.0 ml graduated cylinder with a subsample of the spawn and hand-counting the eggs (fig. 81). It is important to pour off any excess water. Three replicate counts are recommended. The entire spawn is then measured by volume using a 1,000-ml graduated beaker. The total number of eggs is calculated by dividing the total volume by the average egg count obtained from the 25.0-ml samples.

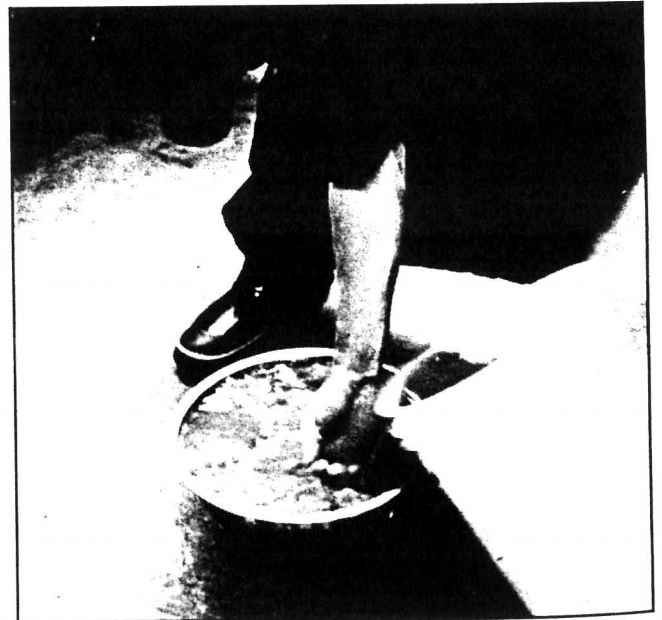

Fig. 80. Adding a fresh silt suspension during de-adhesion of sturgeon eggs.



Fig. 81. Hand counting sturgeon egg samples from a known volume to obtain an estimate of the total spawn.

SECTION IX

Incubation of Eggs and Early Life Stages

Overview

Incubation systems designed for sturgeon eggs must provide a habitat that fosters egg development and discourages mortality from environmental stress, and bacterial and fungal diseases. The sturgeon egg is especially susceptible to fungal infestation, particularly in the later stages of development. Therapeutic treatments for egg fungus are not commonly employed because the holoblastic pattern of sturgeon egg development renders the eggs particularly sensitive to these chemicals. As a result, most hatcheries use incubation-system designs that prevent fungal development or the spread of any initial fungal infestation.

Incubators that provide running water over a stationary population of sturgeon eggs are less successful than those that provide for egg movement. Once a fungus is established in a stationary population of sturgeon eggs, virtually all of the eggs become entrapped by the fungus. Systems that provide gentle turning and agitation of the eggs discourage fungal mycelium attachment from the source of infection to other healthy eggs and reduce the incidence of egg loss to fungus. Sturgeon eggs also exhibit a high tolerance to agitation after closure of the blastopore. Eggs are more sensitive to agitation from the early cleavage stages through gastrulation (approximately 60-78 hr post-fertilization at 15°C). If agitation is not controlled in these stages, significant mortality can result.

Most North American sturgeon hatcheries use adaptations of the MacDonald jar incubator. MacDonald jars provide the egg movement necessary to discourage fungal development and allow adjustment of the water flow as needed to vary the degree of egg movement. Many hatcheries, however, are adopting a two-stage incubation system. The first stage employs a modification of the trout egg barrel incubator, in which the fertilized eggs are placed in an upwelling system that provides good water flow around the eggs without causing egg agitation. After neurulation, the eggs are transferred to the MacDonald jars, where the water flow stirs the eggs and discourages formation of fungal mats.

Incubation Equipment

Simultaneous incubation of eggs from different females in a recirculating system should be avoided. Batches of eggs from different females may affect

each other negatively, especially eggs from an abortive spawn. In addition, secretion of hatching enzyme by more advanced embryos may cause premature hatching in less developed batches.

Modified Trout Egg Barrel

The modified trout egg barrel consists of a fiberglass container 51.0 cm high and 20.3 cm in diameter (fig. 82). The barrel receives ultraviolet (UV)-treated water through a delivery system in the lower end. The water enters the barrel through a series of perforated pipes positioned below a screen that supports a column of gravel. The gravel serves to break up and distribute the water flow evenly as the water rises in the column. A second screen is positioned above the gravel and forms a platform for the sturgeon eggs. The barrel is capped with a third screen that allows water to flow up and out over a lip to a discharge trough. All screens are perforated in a pattern of two holes per cm, with a single hole diameter of 3.0 mm. The barrel is equipped with a longitudinal plexiglass viewing panel for observation of the egg column.

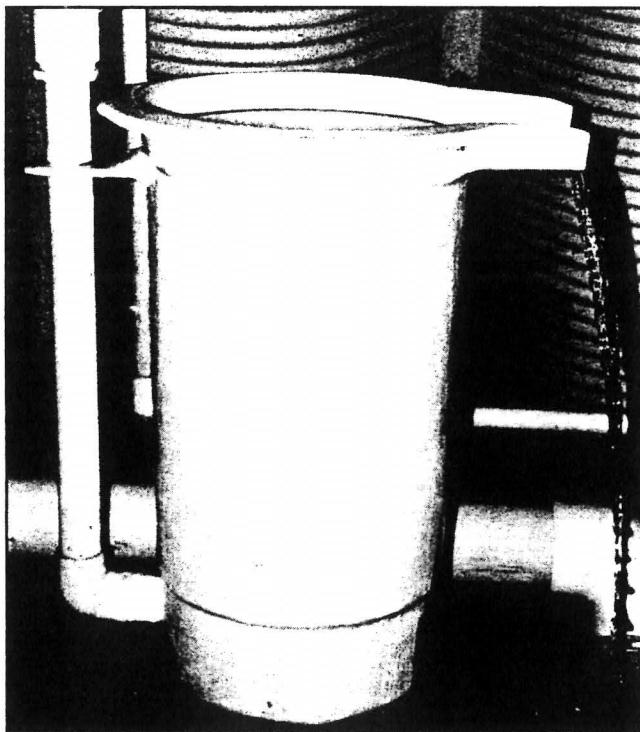

Fig. 82. Modified trout egg barrel used in two-stage incubation systems to incubate sturgeon eggs until the neurulation stage of early embryonic development.

Modified MacDonald Jar

The MacDonald jar system consists of a stand supporting the incubation jars, a head tank that delivers ultraviolet (UV)-treated water to the jars, and a catch basin (figs. 83 and 84). Although UV-treated water is not mandatory, it is recommended. The incubation jars are 13-liter capacity, round-bottom cylinders, 50.0 cm tall, and 20.0 cm in diameter. The material is acrylic plastic that allows direct observation of the eggs and water flow pattern.

Water is passed through a UV sterilizer into an elevated head tank. The head tank is fitted with a standpipe drain that maintains a constant water level and provides a head pressure for flow to the incubation jars. Water enters the jars through water distribution pipes, each equipped with a control valve (figs. 83, 84, and 85). The water enters each incubation unit through a PVC pipe that passes through a jar-cap. The jar-cap has a second hole that allows escape of any air that accumulates between the water-cap interface.

The PVC pipe entering the jar is cut at a 60-degree angle and sleeved in a clear acrylic pipe that extends from the jar-cap to about 2.5 cm from the bottom of the jar (fig. 86). This design provides adequate control of water velocity and egg agitation. The water flows out of the jar, over a lip positioned under the cap, and into a trough that carries the water to a collection tank (fig. 84).

Egg Incubation in the Modified Trout Egg Barrel

The egg barrel is set up with hatchery water at 16°C and minimum water flow. Eggs are placed in the barrel by submerging a bowl of eggs and tilting the bowl until the eggs flow onto the screen above the gravel (figs. 87 and 88). A hand is placed near the lip of the barrel to prevent eggs from flowing out of the system. The barrel can be filled until the level of eggs is just below the top screen when the screen is placed in position. With the top screen removed, the water flow is increased until the eggs at the surface begin to move, and then is cut back to where movement just ceases. The egg column is checked for subsurface movement through the side viewing panel. After rechecking water temperature and flow, the top screen is repositioned, and the egg population is left undisturbed except to monitor development.

Eggs are left to incubate in the barrel until neurulation. If fungus develops, the eggs are immediately transferred to the MacDonald jar system. At 16°C, white sturgeon embryos reach neurulation in about 58 hours. To monitor embryonic development, eggs are removed from the in-

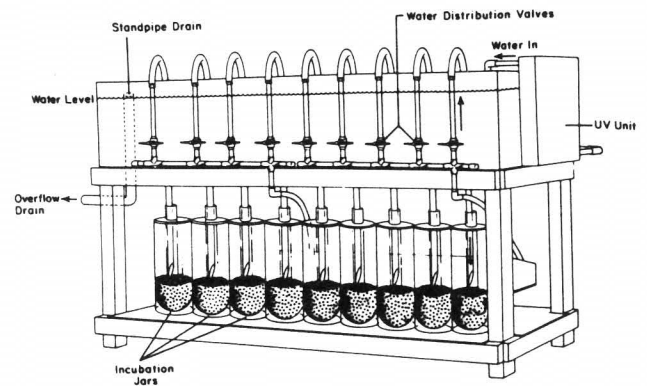

Fig. 83. Diagram of a sturgeon hatchery system using modified MacDonald jars. UV = ultraviolet treatment (Monaco and Doroshov 1983)

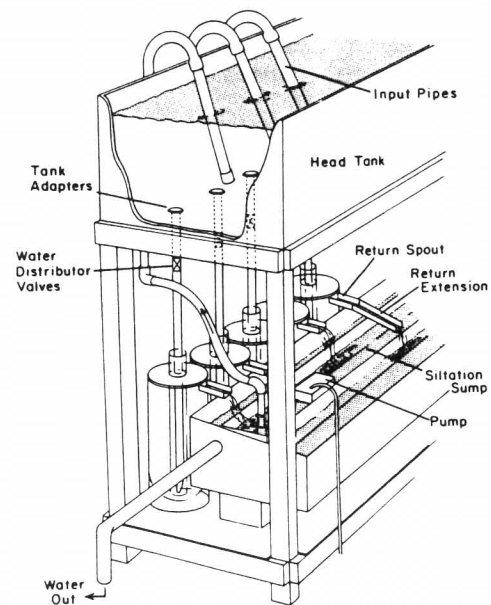

Fig. 84. Diagram of a sturgeon hatchery system showing water flow scheme. (Monaco and Doroshov 1983)

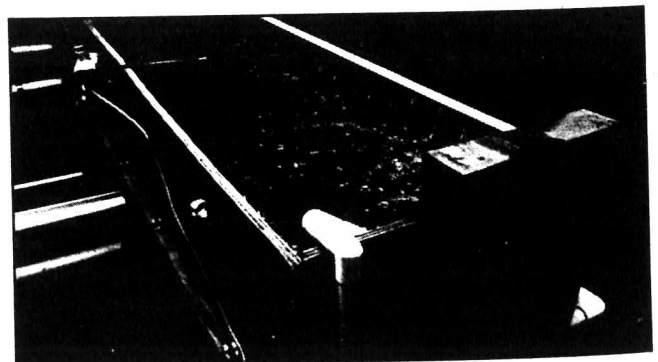

Fig. 85. Spray-bar aeration system in header box and attached UV unit of a sturgeon hatchery system.

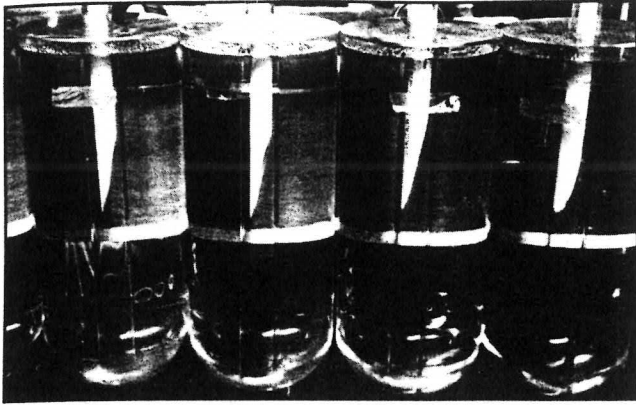

Fig. 86. Modified MacDonald jars showing the clear acrylic sleeve extending to the bottom of the jar and covering the water delivery pipe cut at a 60-degree angle.

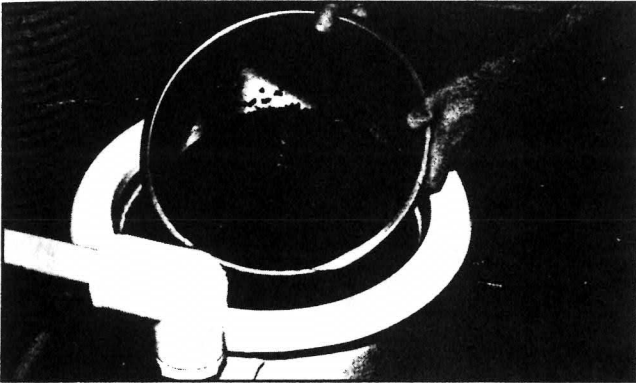

Fig. 87. Loading the modified trout egg barrel with fertilized sturgeon eggs that have undergone de-adhesion.

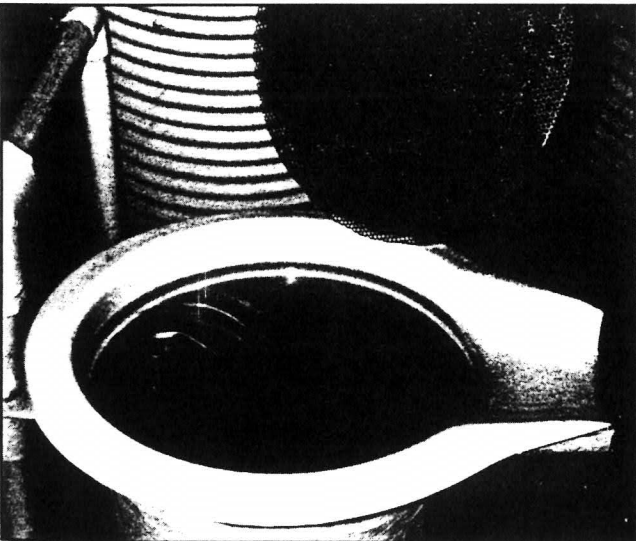

Fig. 88. A 3.0-mm mesh screen used to cap the modified trout egg barrel and prevent sturgeon eggs from flowing out with the discharge water.

cubation system and examined under a dissecting microscope. When the eggs are ready for transfer, the barrel is disconnected from the water inlet pipe, and the eggs are gently poured into suitable transfer containers.

Egg Incubation in the Modified MacDonald Jar

To load the MacDonald jars with eggs, the jars are first filled with water, and the water intake valve is set in the "off" position. Excess water is removed from the egg transfer containers and the eggs are gently poured into the incubation jars with a small beaker until each contains about 13 cm³ (figs. 89 and 90). The inflow valves are then turned on and the water flow adjusted to 30 to 40 percent exchange per minute. The eggs should exhibit an even flow or mix but should not be kicked up into the water column. As the eggs develop they will become more buoyant, and the water flow is then adjusted until the eggs are gently swirling and mixing throughout the lower half of the jar (fig. 91). Some hatchery personnel will provide additional control of fungus in the hatchery jars by temporarily reducing the water flow and siphoning out the dead eggs. Methods also include gently pouring the contents of the jars through an appropriate size screen that retains eggs entrapped in fungal mats and allows free eggs to pass, gently breaking up clusters of good eggs that are entrapped in fungal mycelia.

As the eggs are developing, the water flows from the jars into a trough that leads to a discharge pipe. As the eggs near hatch, the extension leading to the discharge pipe is removed from the jar's lip, and the flow is directed to a second pipe that flows to a fry collection tank. When the eggs hatch, the emerged fry tend to move vertically. The fry are also of a different configuration and the water flow will carry them to the top of the jar. Eventually the water flow carries the young sturgeon up over the jar's lip and into the pipe to the fry collection tank equipped with a screened central drain (figs. 92 and 93). This flow adaptation allows the system to be used simultaneously with different age classes of eggs.

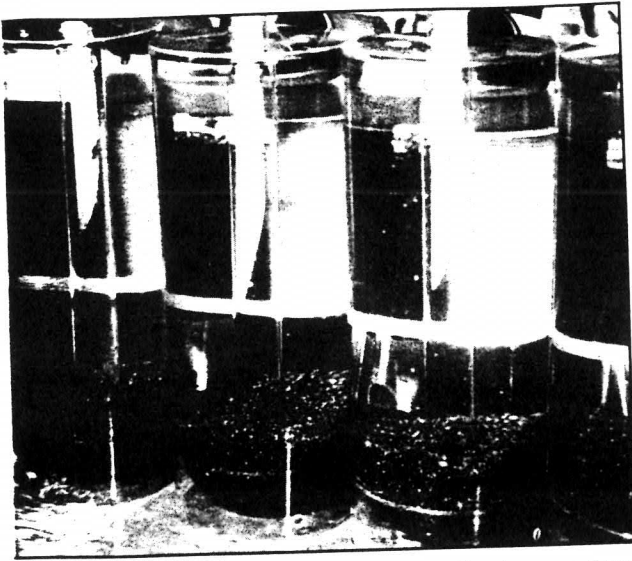

Fig. 89. Modified MacDonal jars loaded with sturgeon eggs before initiation of water flow. (Photo by Jack Kelly Clark)

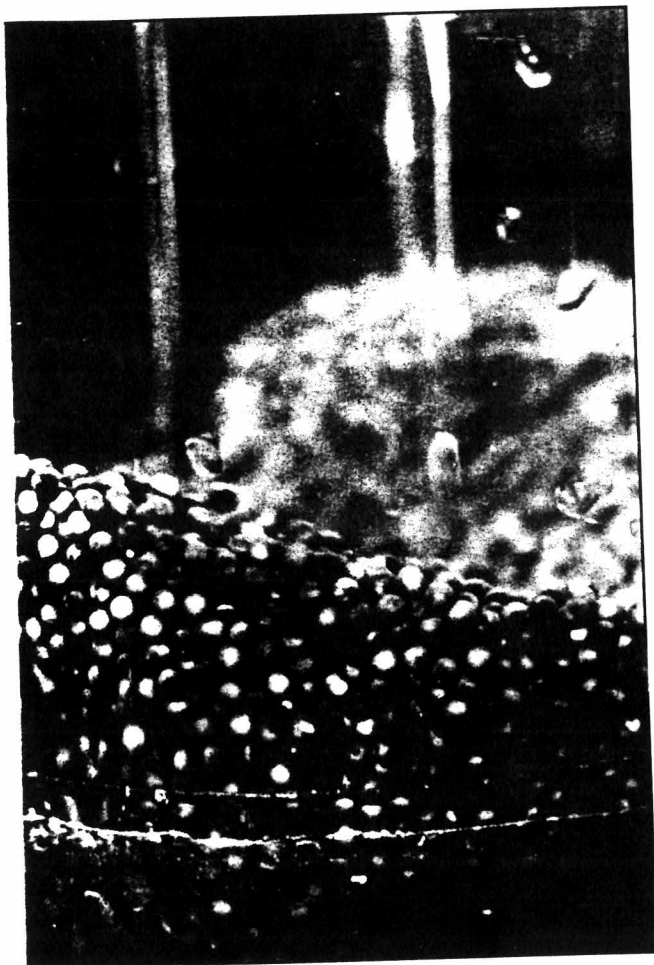

Fig. 90. Close view of eggs in modified MacDonal jars before initiation of water flow.

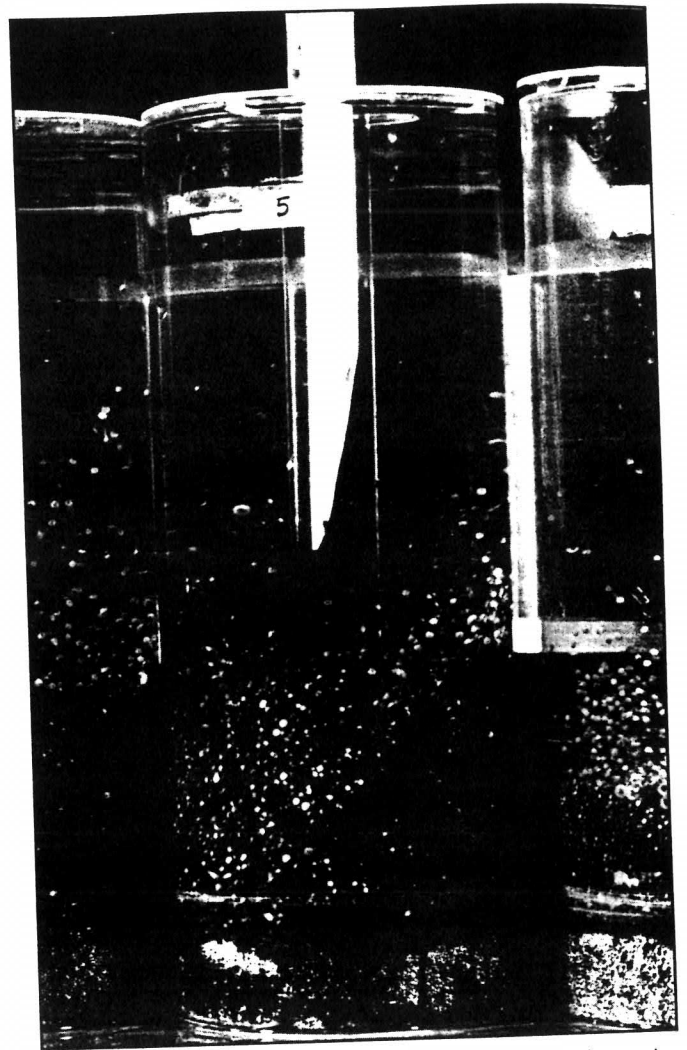

Fig. 91. Sturgeon eggs in modified MacDonal jars after water flow is initiated. (Photo by Jack Kelly Clark)

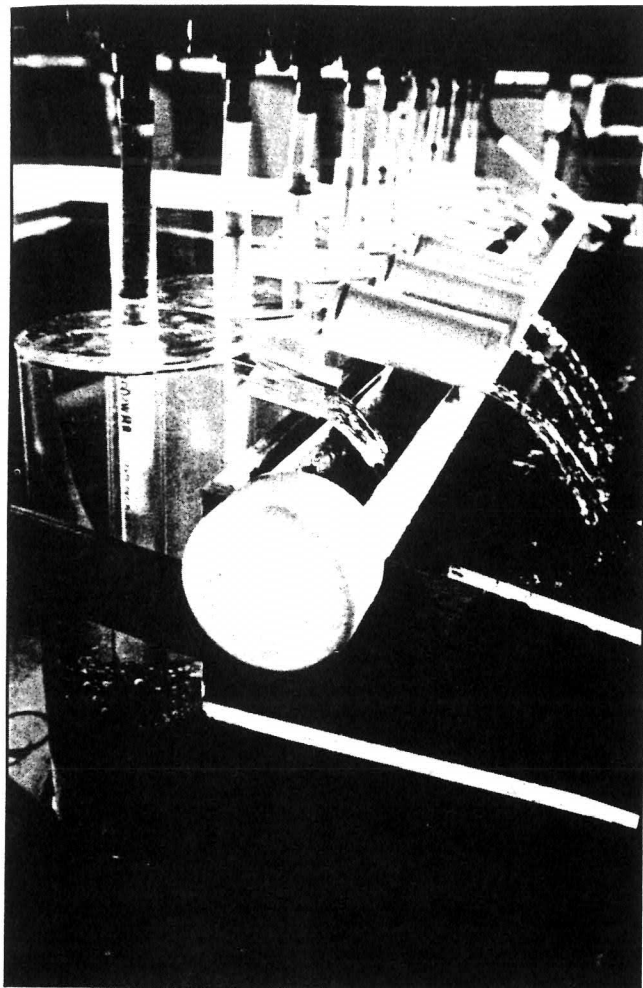

Fig. 92. A sturgeon hatchery system showing the use of extension tubes to direct water flow from the hatchery jars to the water recirculation system, the larval collecting tank, or a silt sump.

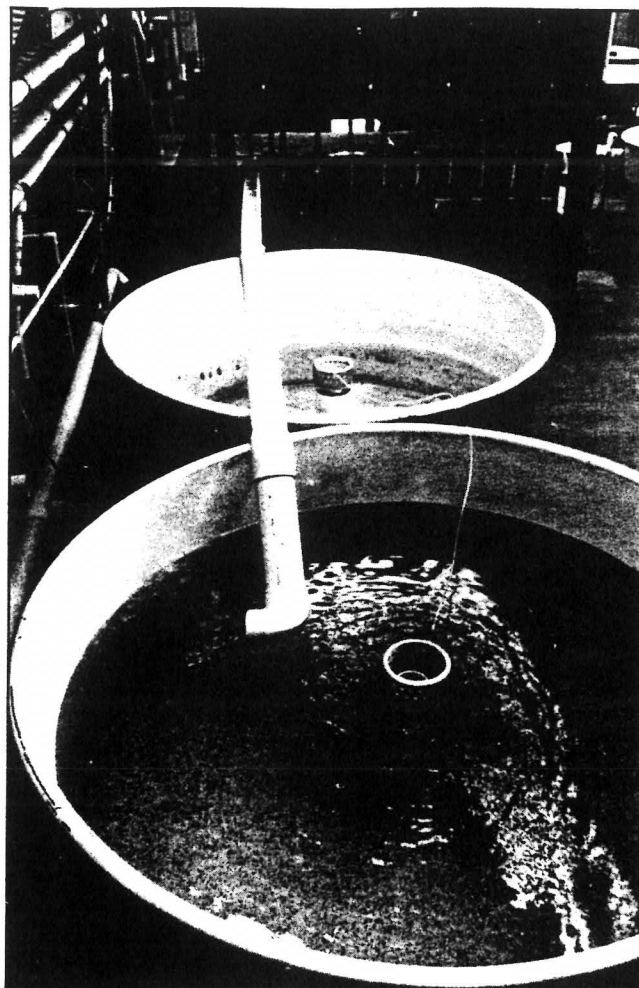

Fig. 93. Sturgeon larval collecting tanks receiving water flow and fry from the hatchery system.



SECTION X

Fingerling Production

Overview

Sturgeon fingerling production is one of the more difficult portions of the hatchery system. Once the larva, or fry, hatches from the egg and depletes its yolk reserves, its survival depends not only on the culture system design but also on nutritional input. At this time, the weakest link in fry and fingerling production is nutrition. Nutrition includes diet formulation, food presentation, feeding schedules, and food preference. If not addressed properly, any one of these factors can negatively influence the animal's growth and survival.

Culture systems developed for fry and fingerling sturgeon are still evolving. This evolution is influenced by the past experience of hatchery managers with other species of finfish and by ongoing projects involving the development of new sturgeon culture systems. Two common approaches are to use systems that reduce daily maintenance, such as circular self-cleaning tanks, or systems that partially mimic conditions that the animal may experience in nature, such as less water current and natural substrates. Future designs may reflect a compromise between the two.

In the following discussion of fingerling production, systems and protocols designed for sturgeon fry and fingerling production for use in both fisheries enhancement and growout programs are described. Success requires the ability to transport animals long distances for further growout at another facility and the ability to grow animals to a size suitable either for stocking in the natural environment or for intensive production growout systems.

Sturgeon Fry Transport

Sturgeon yolk sac fry are often transported from a hatchery to other growout locations. Long-distance transportation of yolk sac fry has been quite successful, as the fry are hardy during this period, need no external nutrients, and metabolic waste accumulation is minimal. Transcontinental shipments of yolk sac fry have been made using techniques developed to ship ornamental fish. The critical factors are proper oxygen and temperature conditions.

In preparation for shipment, the fry are placed in a doubled polyethylene bag secured at the top with rubber bands using a double tie. The bag contains *by volume* at least 80 percent oxygen, no

more than 20 percent water, and no more than 1 percent yolk sac fry. The approximate density of yolk sac fry given here is based on minimal available information, so hatchery operators should adjust these guidelines according to their own experience. The transport bag is placed in an insulated shipping container with a piece of ice wrapped in a towel and placed next to the inflated bag. The box is then sealed, and efforts are made to keep the shipping container in a cool environment during shipment (figs. 94 and 95).

Sturgeon Fry Tanks

Early larval or fry culture tanks may be square, rectangular, or circular in shape, usually determined by availability. Proponents of circular tanks prefer the self-cleaning aspects of the design, whereas those using square or rectangular tanks often maintain that these designs provide a more appropriate environment for the animal. Each design has a different impact on water current patterns, water velocity, distribution of fry and feeds, and fry feeding and resting behavior. Fry have been raised successfully in all of these types of containers, and the tanks can be constructed from fiberglass and resin, wood with fiberglass coating, wood with epoxy coating, or stainless steel. System design should be the choice of the individual hatchery manager.

Circular Fry Tanks

Circular tanks for fry and fingerling rearing are about 122.0 cm in diameter, 46.0 cm in depth, and flat-bottomed. Each tank is equipped with a centered, screened standpipe and a single or double spray bar for water delivery. Water depth is maintained at 30.5 cm, and water volume flow-through is 8.0 to 19.0 L/minute. Oxygen levels of 5.0 mg/L minimum are maintained by the spray system, and accessory air is delivered with airline tubing and air stones (figs. 96 and 97).

Square and Rectangular Fry Tanks

Common designs are flat-bottomed tanks, 183.0 cm × 183.0 cm or 61.0 cm wide × 152.0 cm long and 61.0 cm deep with rounded corners. The tank is equipped with an external standpipe and internal screened sump or, preferably, an internal screened standpipe. Internal sumps are not recommended because young fry can be trapped against the sump screen. Water depth is maintained at 39.0

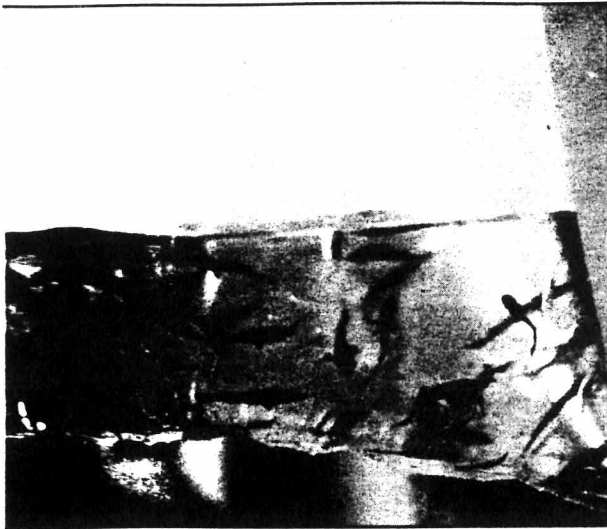

Fig. 95. White sturgeon fingerlings prepared for shipment in double plastic bags.



Fig. 98. Oxygen inflation of double plastic bag containing water and white sturgeon fingerlings for transport.

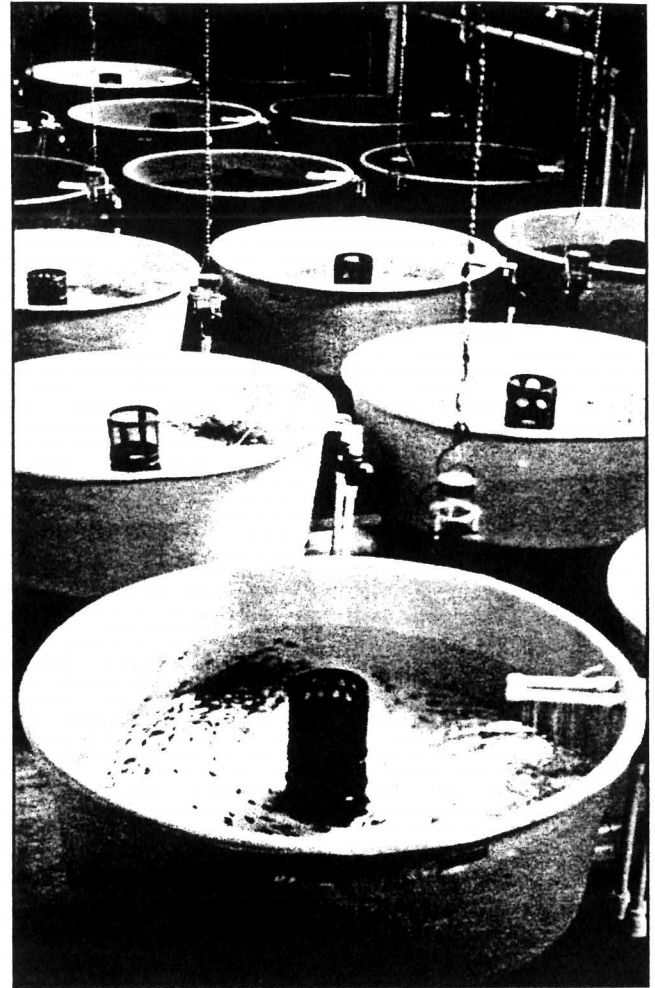

Fig. 96. Circular fiberglass tanks used to rear sturgeon fry.

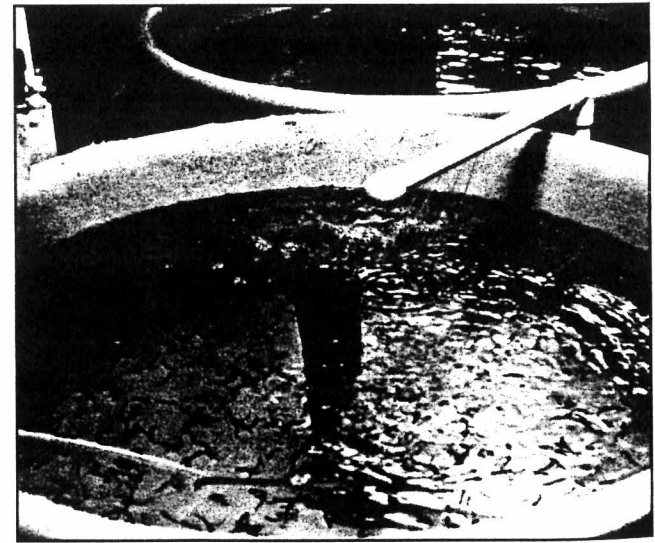

Fig. 97. Close view of spray-bar water delivery system used in circular fry tanks.

cm and delivered through a single or double spray bar at 8.0 to 19.0 L/min. An oxygen concentration of at least 5.0 mg/L is maintained by the spray bars supplemented by air delivered by airlines and air stones (fig. 98).

The stocking density of the fry tanks described above is approximately 15 to 20 yolk sac fry per liter. Thinning of the developing fry should be carried out at a density of 3 to 5 grams per L, or when the fish reach an average of approximately 0.5 grams (assuming 50 percent survival).

Behavior of Young Fry

Fry placed in the tanks soon after hatch will disperse throughout the water column, but will exhibit a slight but significant negative phototaxis. At this stage their pattern of swimming is similar to that of frog tadpole larvae, and they constantly swim in the water column. Within 5 to 6 days posthatch, the fry exhibit a strong negative phototactic response, settle to the bottom of the tank, and aggregate in large clumps. Approximately 3 to 5 days after this transition from pelagic to benthic behavior, larval development is near completion and the fry will be ready to begin feeding (fig. 99).

Initiation of Feeding

The fry should be observed frequently to monitor development and prepare to initiate feeding. The transition from yolk sac nutrition to external feeding is critical and in the case of sturgeon, larval development is considered over when yolk sac absorption is complete and the fry begin external feeding. For best results, feeding should begin before the yolk sac is completely absorbed. Sturgeon larvae respond to external food stimuli before their mouths and digestive tracts are completely developed, and early familiarization with a food scent has proved successful in sturgeon and other finfish hatcheries. Approximately 8 to 14 days posthatch (about 8 to 9 days at 20°C or 13 to 14 days at 16°C), just before the completion of yolk sac absorption, particles of the selected diet may be "milked," or squeezed, between thumb and forefinger to release a cloud of food particles onto the water near the sturgeon. Sturgeon that receive the scent exhibit increased activity, and some hatchery operators believe this introduction eases the transition from yolk nutrition to external feeding on the selected diet. Small amounts of fry feed are introduced to detect when ingestion of external food begins. During this period normal precautions are taken to remove excess food and to maintain good water quality. Once the fry begin feeding they disperse throughout the tank (figs. 100 and 101).

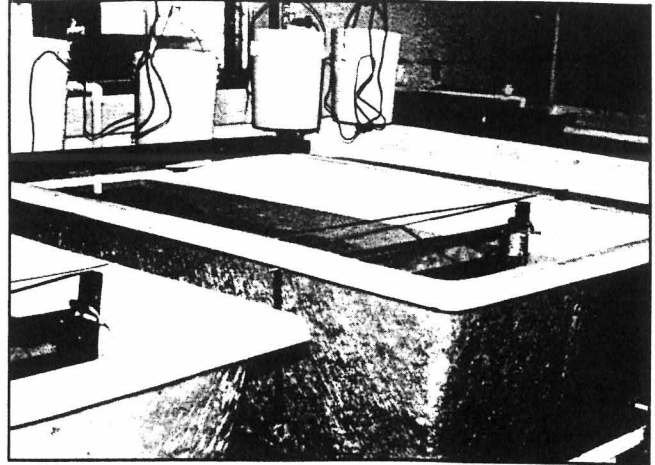

Fig. 98. Rectangular fry tank used in sturgeon culture. (Photo courtesy of Arrowhead Fishery, Gerber, California)

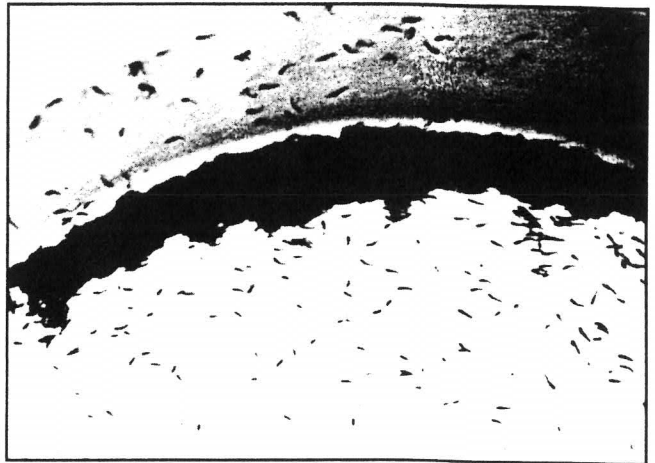

Fig. 99. Six-day posthatch sturgeon fry exhibiting negative phototaxis, settling to the bottom of the tank, and aggregating in clumps.

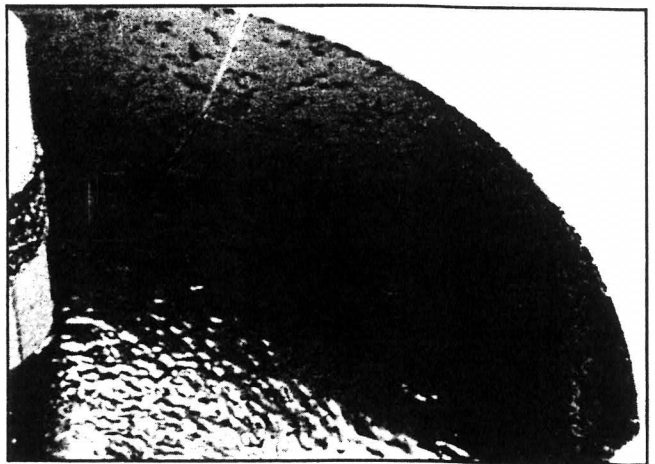

Fig. 100. Thirteen-day posthatch sturgeon fry terminating clumping behavior and scattering throughout water column.



Fig. 101. Closer view of sturgeon following clump dispersal and initiation of feeding.

Selection of Food and Food Preference

The choice of live, natural, or prepared rations for the production of sturgeon fingerlings is still under debate. Although sturgeon rations have yet to be developed, the salmonid diets currently used for market production of sturgeon have provided adequate growth. Prepared rations used as larval diets for sturgeon are considered the minimum required for growth and survival. Significant improvements in sturgeon rations are expected in the near future.

Many new hatcheries feel that natural foods generally provide the best survival and growth for the first weeks of juvenile growth. More experienced hatchery personnel prefer to use prepared rations and feel present feeding regimes and improved system designs coupled with the use of these rations will result in better survival and growth of young sturgeon. They feel that the use of natural food is impractical, adds to the overhead cost of operations, and more often results in the in-

roduction of disease. Hatchery operators have reported the presence of *costia* and *Trichodina* in samples of tubificid worms used to feed young sturgeon.

Some hatcheries have reported that young sturgeon demonstrate a strong preference for food types, and if initially introduced to natural foods, such as fresh, minced tubificid worms, the fish are difficult to wean to prepared rations. Feeding trials demonstrate that a strong or exclusive preference for tubificid worms develops quickly, apparently because the fry are more prepared physiologically and anatomically to accept and assimilate natural foods. This strong or exclusive preference for natural foods has resulted in refusal to ingest prepared ration, smaller meal size during a feeding period, suppressed growth, and severe mortalities when the fish are switched from natural food to prepared rations. The reluctance of the fish to initially consume the artificial diet, excess feed, and the resultant bacterial growth can become a significant problem. *Myxobacter* and *Flexibacter* thrive under these conditions and are considered major contributors to larval mortality.

When sturgeon fingerlings have reached 2 months of age, growth is reported to be significantly better with prepared rations used exclusively than with live diets. This may be due to anatomical and enzymatic changes in the gut that influence the animal's ability to assimilate different food types. This growth difference may also be related to a lack of availability of appropriate live foods to feed advanced fingerlings. As a result, some hatchery managers recommend introducing prepared rations at the initiation of external feeding, absorbing some mortality and slower growth during the fry stage, and regaining the advantage at the fingerling stage by avoiding the weaning process (see Appendix 19 regarding combined feeding of natural and prepared foods).

Prepared Rations

Prepared rations specifically designed for sturgeon are being developed. At present, the artificial feeds commonly used for sturgeon fry and fingerlings are those formulated for salmonids. The moist and semimoist rations appear more palatable than dry rations, particularly at the initiation of external feeding. Once the fry have accepted the moist ration and have developed sufficiently to handle a more solid pellet, they are carefully weaned to the cheaper, more easily handled dry diet. Two of these diets, Biodiet (semimoist ration) and Silvercup (dry ration), initially developed for salmonids, are being used extensively in commercial and public sturgeon hatcheries (tables 11 and 12).

TABLE 11. Research protocol: commercial rations developed for salmonids and currently used for feeding of larval and fingerling sturgeon at UC Davis*,†

Commercial ration‡	Approximate duration of feeding§ (days)	Approximate feed rates (approximate body weight per day) (%)
Biodiet #2	4**	30
Transition Mix of Biodiet #2 and Biodiet #3††	3	15
Biodiet #3	4	10
Transition Mix of Biodiet #3 and Biodiet #4††	3	7
Biodiet #4	10	4
Transition Mix of Biodiet #4 and Silvercup #2††	3	4
Silvercup #2	To point that animal is able to make transition from starter/crumbles to smallest pellet size.††	2-4

- * Trade and company names mentioned are for informational purposes only. This does not imply University of California or U.S. Government endorsement of the product.
- † At a temperature range of 16°-18°C.
- ‡ Some hatcheries use medicated feeds to prevent disease.
- § Times for diet transitions must be adjusted according to the actual rate of growth of the animals, which is dependent on water temperature and other factors. Therefore, the table gives the approximate number of days to use a particular ration, rather than a specific age of the animal at which to start and stop each ration.
- || Excess feed should be cleaned 1-2 times per day for disease prevention.
- ** Feed initiation begins just before completion of yolk sac absorption (8-14 days posthatch, see pages 22 and 69).
- †† All transitions are accomplished with the following exchange sequence: 75% current ration-25% new ration; 50% current ration-50% new ration; 25% current ration-75% new ration; 100% new ration.

Fry Feeding Rates and Feeding Frequency

Once external feeding is initiated, some managers feed the fry at a rate of 25 percent of the tank's total biomass every 24 hours, with feedings at intervals of 2 or 3 hours. Other managers prefer to feed the fry *ad libitum* at 2-hour intervals, with continuous monitoring of feeding activities. Manual feeding provides an immediate awareness of problems such as abnormal behavior or lack of feeding altogether. This style requires extensive use of personnel but has proven worth the effort for new hatchery personnel. Many experienced hatchery personnel prefer to use automatic feeding devices, especially once feeding protocols are initiated, using high quality mechanical feeding units. Better automatic feeders provide a consistent presentation and uniform delivery. Feeding of fry may also be checked by capturing fry

TABLE 12. Commercial hatchery protocol: commercial rations developed for salmonids and currently used for feeding larval and fingerling sturgeon cultured in North America*,†

Commercial ration‡	Approximate duration of feeding§ (days)	Approximate feed rates (approximate body weight per day) (%)
Biodiet #3	5**	30
Transition Mix of Biodiet #3 and Biodiet #4††	2-3	15
Biodiet #4	2	10
Transition Mix of Biodiet #4 and Silvercup #2††	2-3	7
Silvercup #2	To point that animal is able to make transition from starter/crumbles to smallest pellet size.††	2-4

- * Trade and company names mentioned are for informational purposes only. This does not imply University of California or U.S. Government endorsement of the product.
- † At a temperature range of 16°-18°C.
- ‡ Some hatcheries use medicated feeds to prevent disease.
- § Times for diet transitions must be adjusted according to the actual rate of growth of the animals, which is dependent on water temperature and other factors. Therefore, the table gives the approximate number of days to use a particular ration, rather than a specific age of the animal at which to start and stop each ration.
- || Excess feed should be cleaned 1-2 times per day for disease prevention.
- ** Feed initiation begins just before completion of yolk sac absorption (8-14 days posthatch, see pages 22 and 29).
- †† All transitions are accomplished with the following exchange sequence: 75% current ration-25% new ration; 50% current ration-50% new ration; 25% current ration-75% new ration; 100% new ration.

with a glass beaker and examining the gut for the presence of food while holding the sample up to a light source.

The early feeding periods must be monitored continuously and feeding rates adjusted based on food acceptance and amount of uneaten food left in the tank. Other critical periods are during ration transitions. If any problems are encountered during transition from one ration to another, or from one ration size to another, the recommended procedure is to drop back to the previous ration type for several days and then slowly proceed with the transition. The transition from one type of feed to another (e.g., semimoist Biodiet to dry Silvercup) may be facilitated by dropping back a step in the particle size of the new diet. Although care must be taken in advancing the larvae and fry to new rations and rations of different particle

size. Most hatchery managers prefer to move the animals through the initial diets and ration particle sizes as quickly as allowed by the growth and health of the fish.

Disease Treatments for Fingerling Sturgeon

Few hatchery operators in North America have experience in treating diseases of fingerling sturgeon in intensive culture. Sturgeon have been reported as having many of the diseases seen in other fish, and treatments have been modifications of those used for salmonids and other cultured species. As more experience is gained in the hatchery rearing of sturgeon fingerlings, the treatments will be refined or changed. Tables 13 and 14 present some of the more common and successful treatments used for white sturgeon fingerlings in North America.

TABLE 13. Common treatments used to control diseases observed among cultured white sturgeon*,†

Disease‡	Cause	Treatment
Myxobolus	<i>Myxobacter sp.</i> bacteria	Oxytetracycline‡ 4-8 g/100 lbs feed fed daily for 10 days Furanace‡ 4-8 ppm, static water bath, 1 hour flush repeated daily
Columnaris	<i>Flexibacter columnaris</i> bacteria	Same treatment as outlined above
Costia	<i>Chthyobodo necatrix</i> flagellated protozoan	Formalin 1:10,000, static water bath, 1 hour flush repeated if needed
External lesions	Assorted fungi	Formalin as outlined above Methylene Blue used experimentally at 5.0 ppm, static water bath, or in excess of 5.0 ppm in 1 hour flush Malachite Green found toxic at 1.0 and 2.0 ppm Salt approximately 3% for adults

* When using chemicals or drugs, always test a small lot of fish with the treatment to be used. Observe these fish closely for any complications and proceed with treating the entire lot. It is recommended that treatments be conducted in consultation with a qualified fish pathologist.

† The names mentioned are for informational purposes only and do not imply University of California or U.S. Government endorsement of the product. All uses of fishery compounds must be registered by appropriate State and/or Federal agencies. Only those uses described on the label are permitted and the rates listed.

‡ Oxytetracycline and the nitrofurans are not FDA approved for use. For the nitrofurans a 21-day withdrawal period is required with the use of these drugs.

TABLE 14. Unidentified diseases and diseases with no developed treatment to date

Disease agent	Disease	Signs/associations
<i>Saprolegnia sp.</i>	Internal fungus Infection of gut spreading to body cavity and internal organs	Observed in fish fed spoiled live diets
Adenovirus	Virus infecting cells of gut	Signs of starvation
Unknown	Liver disease	Livers extremely pale yellow to waxy; fish usually thin and weak
Unknown	Gut inflation, fish lie upside down with notice- able gas distention in gut	Gas trapped in gut, perhaps associated with supersaturated water or with nutrition

Stocking Fingerling Sturgeon

Most sturgeon hatchery managers consider the optimum fish size for stocking fingerling sturgeon for either natural environment enhancement programs or food production growout systems is about 15.0 cm long. However, sturgeon 5.0 to 7.0 cm long have been successfully stocked in these systems (fig. 102). The larger fingerlings are better conditioned to find artificial feeds and survive pond and large tank conditions. When stocking in natural systems for fisheries enhancement, the fingerlings are often retained in a floating cage for 24 hours to allow the fish to adjust to the new environmental stimuli before release. If transferred directly to natural waters, lake sturgeon have been reported docile and readily approached. When held in cages before release, however, they exhibited a more "stream-wise" behavior.

Normal precautions should be taken when stocking sturgeon in larger production facilities or in natural waters for mitigation purposes. The fingerlings should be acclimated to the new water for 20 or 30 minutes by gradually exchanging the water in the transport container with the receiving water. This gradual acclimation assures no abrupt changes in temperature, pH, or other physical factors that would stress the fish.

Hatchery-reared fingerlings have been released in natural sturgeon habitats through cooperative agreements with state agencies and the U.S. Fish and Wildlife Service. Indications are that these programs could benefit sturgeon populations in North America, especially those species considered threatened or endangered. In addition to creating such mitigation programs, research sponsored by the U.S. Fish and Wildlife Service has already stimulated development of a small commercial sturgeon aquaculture industry, and this industry shows signs of growing and contributing significantly to aquaculture production in North America.

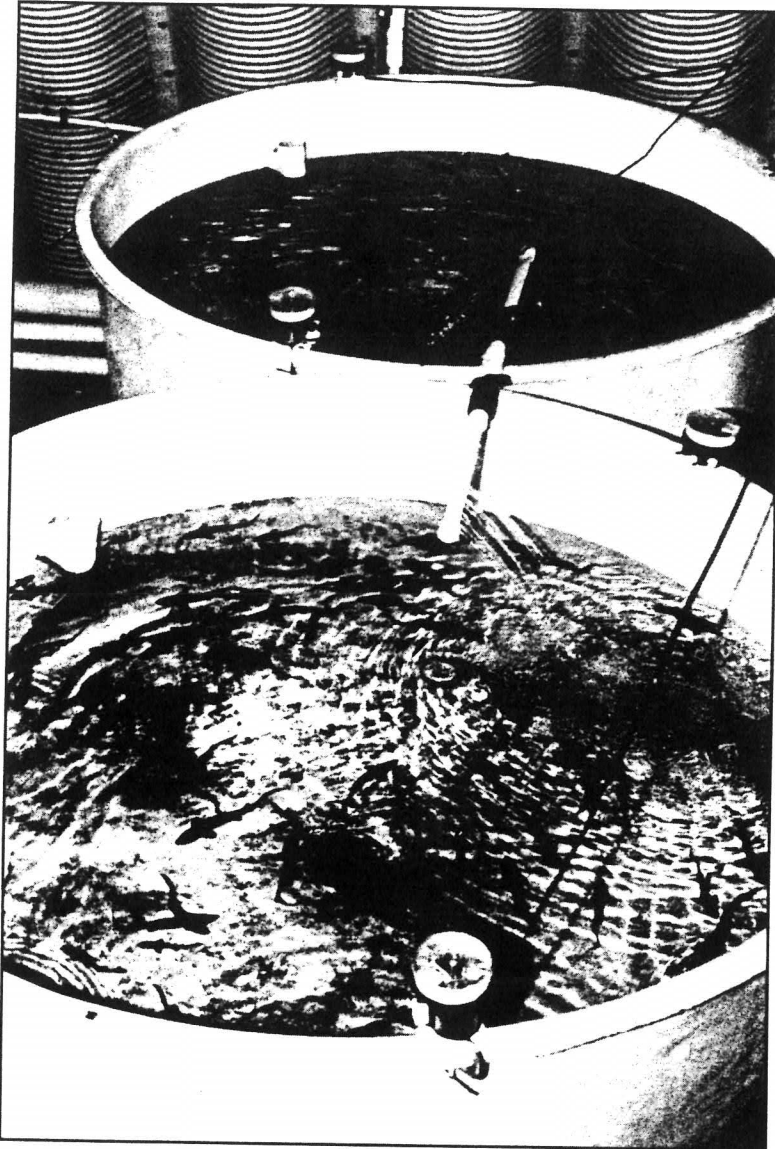
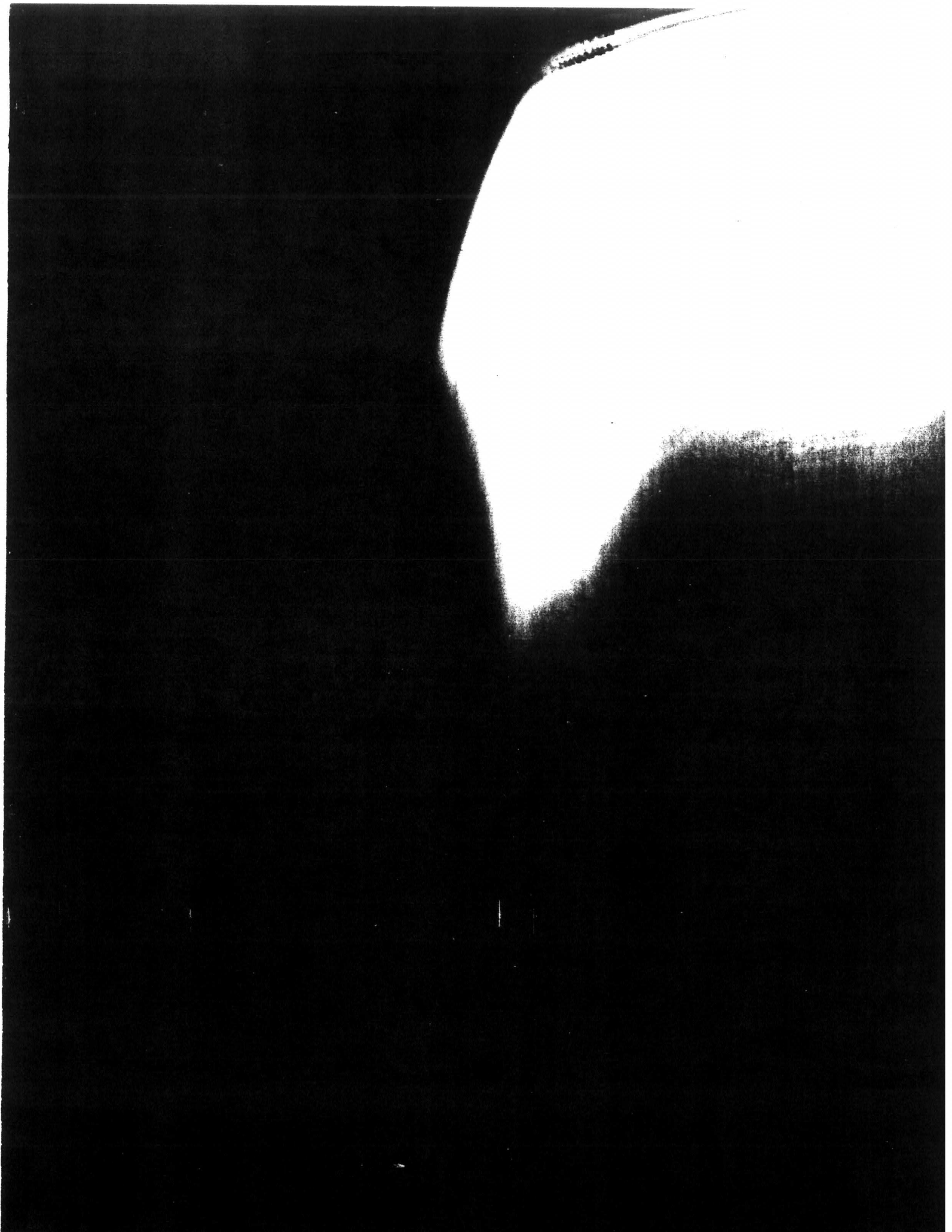

Fig. 102. Circular fiberglass tanks stocked with a low density of advanced sturgeon fingerlings ready for stocking.

APPENDIXES



APPENDIX 1
Metric/English Conversion Table

Metric		English
	Length	
1 centimeter	=	0.39 inch
2.54 centimeters	=	1 inch
30.5 centimeters	=	1 foot
1 meter	=	1.09 yards
0.91 meters	=	1 yard
	Mass	
1 gram	=	0.035 ounce
28.35 grams	=	1 ounce
1 kilogram	=	2.2 pounds
0.45 kilogram	=	1 pound
1 metric ton	=	1.10 English tons
0.91 metric ton	=	1 English ton (2,000 pounds)
	Volume	
1 liter	=	0.26 gallon
3.785 liters	=	1 gallon
29.57 milliliters	=	1 ounce
	Flow Rate	
1 liter/second	=	0.035 cubic foot/second
28.32 liters/second	=	1 cubic foot/second
1 liter/minute	=	0.264 gallon/minute
3.785 liters/minute	=	1 gallon/minute
	Concentration	
1 milligram/liter	=	1 part per million
3.785 milligram/gallon	=	1 part per million

APPENDIX 2

Sturgeon Fisheries Statistics

Fisheries statistics for sturgeon in the United States are maintained by the National Marine Fisheries Service of the United States Department of Commerce. The reported landings for sturgeon are estimates and do not reflect the total number or weight of fish taken. Unreported fish taken both legally and illegally in commercial and sports fisheries add significantly to the total amount removed from national waters.

The primary commercial sturgeon fisheries in the United States are for white sturgeon in the Pacific Northwest and Atlantic sturgeon in some southeastern states. Other species such as lake and shovelnose sturgeon support small fisheries, but the total landings are considered relatively insignificant to commercial fisheries statistics and are not often reported. The following data represent statistics for sturgeon fisheries obtained from regional offices of the National Marine Fisheries Service covering the period 1971-1982, and are presented here only to indicate estimates of the national sturgeon fishery for that period. Accurate data for several locations are not available, and in recent years the fishery in some states has been limited or closed.

Mean annual catch of Atlantic sturgeon, *Acipenser oxyrinchus*, harvested from the southeast coastal region of the United States from 1971-1982. Data presented in pounds (lb) and kilograms (kg) rounded to the nearest whole number.

State	Lb/Kg	State	Lb/Kg
Virginia	6,474/2,939	Alabama	Nonreported
North Carolina	55,775/25,322	Mississippi	Nonreported
South Carolina	85,898/38,998	Louisiana	Nonreported
Georgia	9,727/4,416	Texas	Nonreported
Florida	3,494/1,586		

Mean annual catch of white sturgeon, *A. transmontanus* harvested from the Pacific Northwest from 1968-1983. Data presented in pounds (lb) and kilograms (kg) rounded to the nearest whole number.

Location	Lb/Kg
Puget Sound, Washington	3,000/1,362
Grays Harbor, Washington	48,000/21,792
Wallapa Bay, Washington	Nonreported
Columbia River, Washington	171,000/77,634
Ocean Fishery, Washington & Oregon	16,000/7,264

APPENDIX 3

Summary of Current Sturgeon Culture Techniques by Species

Atlantic Sturgeon

Atlantic sturgeon, *A. oxyrinchus*, are being successfully spawned and fingerlings produced. Migrating sturgeon are captured with anchored gill nets from late February to early May at water temperatures of 9.5°-23.0°C. Fish are transported to the hatchery in freshwater at 15°-23°C. At the hatchery, broodfish are either transferred to a 0.1 ha freshwater earthen pond and held for 12-13 days before spawning induction or held individually and in small groups in round fiberglass tanks with water supplied at 15-38 L/minute at 15°-27°C.

Eggs are surgically removed and examined for ripeness based on the position of the germinal vesicle in relation to the animal pole. To induce spawning, intramuscular injections of acetone-dried or fresh sturgeon pituitary are given, with the number of injections based on the stage of egg development. Dosage for females varies from 1.5-2.0 mg dry weight of pituitary per kg of fish. Males are injected every 1-3 days with injections of 0.5 mg/kg.

Egg and sperm are mixed for 1-2 minutes, washed, and then mixed with pond mud or diatomaceous earth to prevent clumping. Fertilized eggs are stirred and washed for 10-30 minutes and placed in MacDonald hatching jars. Reservoir water is circulated through the jars at 7.0 L/minute. Although some problems with fungal infection are reported, eggs cultured by these methods have been hatched in 108-140 hours at water temperatures ranging from 14.5°-22°C, in 121-140 hours at 16°-19°C, and in 72-100 hours at 19°-23°C. The yolk sac is absorbed 9-11 days posthatch. The fry are fed a diet of ground beef liver mixed with salmon mash and supplemented with live *Artemia* nauplii.

Egg and sperm are mixed for 1-2 minutes, washed, and then mixed with pond mud or diatomaceous earth to prevent clumping. Fertilized eggs are stirred and washed for 10-30 minutes and placed in MacDonald hatching jars. Reservoir water is circulated through the jars at 7.0 L/minute. Although some problems with fungal infection are reported, eggs cultured by these methods have been hatched in 108-140 hours at water temperatures ranging from 14.5°-22°C, in 121-140 hours at 16°-19°C, and in 72-100 hours at 19°-23°C. The yolk sac is absorbed 9-11 days posthatch. The fry are fed a diet of ground beef liver mixed with salmon mash and supplemented with live *Artemia* nauplii.

(References: 187, 189, 191)

Lake Sturgeon

Lake sturgeon, *A. fulvescens*, are being artificially spawned and subsequently reared in net cages. Spawning fish are dip-netted from the Fox and Wolf Rivers in central Wisconsin in late April and early May when the water is about 12°C, and sperm and eggs are collected in the field. The fish are then released.

Milt is expressed from ripe males by palpation of the abdomen, drawn into a syringe, and stored on ice in glass vials. Eggs are collected from ripe females through a 5.0- to 7.0-cm incision anterior and lateral to the vent. The incision is closed with dissolving sutures. The eggs are placed in a wet plastic pan, covered with water, stirred, and allowed to stand for 2 to 3 minutes. To reduce adhesiveness, a bentonite clay solution is then added to the eggs. After being washed with freshwater for 15 minutes, the eggs are fertilized and transported to the hatchery in foam-lined boxes.

At the hatchery, the eggs are screened, reelayed, placed in MacDonald hatching jars, and incubated at water temperatures ranging from 13°-16°C. Hatching occurs within 4 to 6 days, with resulting 34%-92% hatch rate. The yolk is absorbed within 10 days posthatch. At this time, the fry are positively phototactic, swim actively, and feed on live brine shrimp nauplii, with little interest in dry food. At 30.0 mm long, the fry begin feeding on larger zooplankters, but at the small fingerling stage an acceptable food has not been found.

Other studies examined the effect of temperature on early development of lake sturgeon. The time to hatch was 80-105 hours at 20°C and 380-430 hours at 10°C. Yolk depletion and the initiation of external feeding occurred at 310 hours at 20°C and at 1300 hours at 10°C. The optimal temperature for embryos and early larvae was shown to be 14°-17°C.

(References: 2, 14, 19, 20, 51, 72, 212, 213)

Shortnose Sturgeon

Shortnose sturgeon, *A. brevirostrum*, have been cultured only recently. The first successful culture trials based on induced spawning were in 1983. Adult sturgeon were captured by electro-fishing or with gill nets. Ripe fish are generally obtained in February and March at water temperatures between 7.2° and 13.2°C.

Captured fish are held in a 1.4 × 1.5 m deep cylindrical floating cage of 6 mm mesh until transport to the hatchery. At the hatchery, fish are held in cylindrical tanks 1.8 × 0.8 m deep. The volume of the tanks is approximately 1,700 L. Freshwater at 17°-18°C is continuously supplied from a well or reservoir.

Females are held in the hatchery tanks for 3-4 weeks before spawning induction, and males are held for up to 6 weeks. To induce spawning, the sturgeon are given intramuscular injections of acetone-dried pituitary glands homogenized in 1.0-2.0 ml of distilled water containing 10% dimethylsulfoxide (DMSO). Females are injected with carp pituitary at 8.0 mg/kg body weight or acetone-dried Atlantic sturgeon pituitary at 2.6-3.3 mg/kg body weight. Males are injected with sturgeon pituitary at 1.5-3.0 mg/kg. The females ovulate within 22-30.5 hours after injection.

Ovulated eggs are removed through an abdominal incision or manually stripped through the genital opening. Eggs and refrigerated or fresh milt are mixed and stirred gently for 30 seconds to 1 minute. Water is then added to this mixture, and after 5 minutes mud or diatomaceous earth is stirred into the mixture for 15-20 minutes to prevent clumping of the eggs.

The fertilized eggs are incubated in MacDonald hatching jars or Heath Techna trays. To prevent the development of fungus, the eggs are treated daily with formalin at 1,670 mg/L for 10 minutes using a constant flow method. Hatching begins at 111-121 hours at 20°C and at 136 hours at 18°C.

Larvae are reared in fiberglass and aluminum troughs 2.4 × 0.5 × 0.2 m deep. The troughs are connected to a flow-through freshwater system and supplied continuously with well or reservoir water at temperatures ranging from 17°-23°C. Formalin is applied at a rate of 1.775 mg/L for 1 hour on a regular basis, and streptomycin/penicillin is administered occasionally.

Beginning on the seventh day, the larvae are offered live *Artemia* nauplii and salmon starter meal. After yolk sac absorption, finely ground beef liver is added to the diet. The diet is supplemented with experimental feeds and commercial semimoist and dry rations the following week. About 3 weeks after yolk sac absorption, the diet is primarily beef liver and commercial dry rations.

Juveniles are reared in 0.24 ha outdoor ponds with a mean depth of 1.6 m or indoors in fiberglass tanks 3.7 m × 0.8 m deep and connected to a freshwater recirculation system. The diet consists of the pond's benthic fauna, with minimal supplementation of dry rations. The tank-reared juveniles receive a variety of diets including beef liver, squid, earthworms, polychaete worms, dry salmon and trout rations, and experimental diets. Later, the diet consists of #3 and #4 trout crumbles.

Significant mortalities occur in both systems and appear primarily due to shipping and handling stress following stocking. In addition, Furan 2 administered to 109-day-old juveniles at a level below that recommended for other species caused 91.4% mortality within 24 hours, suggesting a lethal sensitivity of shortnose sturgeon to this treatment.

Once spawning induction is complete, broodfish are stocked in cylindrical and raceway tanks with a volume of 730-8,600 L or a 0.24 ha pond 1.6 m deep. The tanks are supplied with recirculated water at an exchange rate of 4-15 turnovers daily. The diet of the tank-held adults is composed of fish, squid, molluscs, crustaceans, worms, and beef liver. The pond-held fish do not receive any supplementation. Survival is high in both systems, but the tank-held fish do not feed and show substantial weight loss.

Water quality in adult and juvenile rearing systems is similar with water temperatures from 22°-24°C, oxygen at 7.0-8.0 mg/L, and a pH of 7.8-8.0. The tank nursery systems are preferred for raising small juveniles because they permit more control of water quality than outdoor pond systems.

(References: 187, 188)

Paddlefish

Paddlefish, *Polyodon spathula*, are being cultured in agency and private hatcheries. Contemporary work on paddlefish in North America began around 1960. Paddlefish were artificially inseminated, and the resulting eggs were incubated in a Robertson trout egg incubator in running spring water at a water temperature of 12.8°-13.9°C. The eggs were treated daily with malachite green, and hatching began on the 12th day after spawning. The rate of larval survival in troughs was low, and only pond-raised paddlefish survived beyond the first few days and continued to grow and develop.

Spawning induction of paddlefish using intraperitoneal injections was reported in 1962, but no successes were reported until 1965 when injections of extracts of acetone-dried carp and paddlefish pituitaries were first used. After fertilization, eggs were placed in Robertson incubators with a flow rate of 15.1 L/min of lake water and a water temperature of 13.9°-16.1°C. Hatching began nine days after fertilization.

Between 1965 and 1971 research on induced spawning of paddlefish intensified, and in one series of studies five hormones and various dosage rates were tested. Sexually mature paddlefish were caught with gill nets and held in ponds. Hormones tested included human chorionic gonadotropin, follicle stimulating hormone, luteinizing hormone, and paddlefish and carp pituitary glands. Pituitary glands were preserved by acetone-drying or by quick freezing with dry ice. Before injection, homogenized, acetone-dried pituitary glands were mixed with 0.5-1.0 cc deionized water. Injections were made with a size 20 needle about 3 inches anterior to the symphysis of the pelvic fins and to the side of the mid-ventral line. Glands from paddlefish of comparable weight to the fish being injected produced the best results.

Female paddlefish weighing between 18.1-22.7 kg ovulated following intraperitoneal injections of paddlefish or carp pituitary gland suspensions. The best response was observed using two or three daily injections of a dose consisting of two paddlefish pituitary glands per injection.

Male paddlefish weighing between 11.3-15.9 kg spermiated following intraperitoneal injections of paddlefish pituitary administered at a rate of one gland per injection and with injections of carp pituitary glands. Injections of paddlefish pituitary were most dependable. In general, only one dose of pituitary extract was required to induce spermiation, and sperm was collected using a catheter.

Fertilization was accomplished by stripping the eggs into a plastic container, adding sperm, and stirring in a small quantity of silty water to activate the sperm and prevent clumping. Stirring was continued, and clean water was added gradually to remove the silt. The eggs were then placed in large containers to harden before transfer to hatching facilities.

Eggs were hatched in Robertson trout egg incubators or incubator jars. Incubator jars gave the best results. Water flow was adjusted to roll the eggs vigorously, and a 2-minute flush of 65 ppm malachite green was applied daily. Eggs began hatching in 10-12 days at

water temperatures between 11.1°-14.4°C or in eight days at temperatures near 15.5°C. Over the course of the experiment, the incubator jars emptied into a screened collecting receptacle. As the larvae were carried by the flow of water into collection tanks. After hatching was complete, the fry were stocked in ponds.

Studies on the feeding ecology and growth of paddlefish raised in hatchery ponds showed that larvae under 120 mm are particulate feeders, whereas adults are filter feeders. At the juvenile feeding stage large, slow-moving cladoceran species, especially *Daphnia*, are particularly critical for normal development. Adults filter available zooplankton from the water using gill rakers and show less selection or avoidance than at the particulate feeding stage.

(References: 152, 168, 169, 177)

APPENDIX 4 "Oviduct" Structure

Both male and female sturgeon possess a paramesonephritic (mullerian) duct in the adult stage. The duct opens internally into the coelomic cavity and externally at the genital vent. The duct is the "oviduct" for the passage of eggs in the female. It is also present in the male but its function is unknown. The tube possesses a one-way valve near the upper third of its length. In the female the valve functions as a control over the discharge of the eggs into the coelomic cavity during oviposition. Because of the oviduct's structure, its span across the coelomic cavity, and the presence of the valve, eggs cannot be efficiently removed from the body cavity as done with salmonids. Some success has been achieved with stripping techniques but, like most commercial hatchery operators, most sturgeon hatchery personnel prefer to remove eggs through an incision in the body wall.

Diagram of the white sturgeon's oviduct, including the paramesonephritic duct

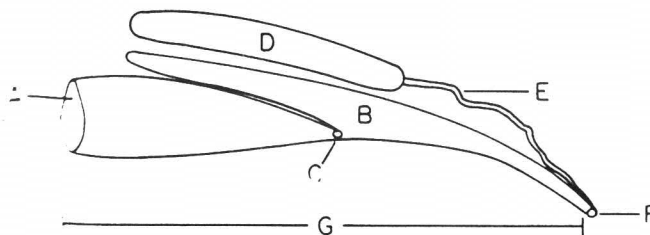

- A - opening of oviduct opening left into the coelomic cavity
- B - paramesonephritic duct
- C - duct valve
- D - duct
- E - duct
- F - genital pore
- G - duct

APPENDIX 5

Snagging Sturgeon

Snagging is accomplished with a single piece rod rated at 40 lb and a reel capable of holding 900-1,050 ft of 50-lb test monofilament line. The line is attached to a 120-lb test monofilament leader equipped with a size 5 hook and weighted with an 8-oz sinker. This basic equipment has been used successfully for snagging sturgeon throughout the Pacific continental states. Good sources for obtaining information on fishing techniques for adult sturgeon are area sportsfishing publications and associations. Information often includes a review of equipment, techniques, and information on the natural history of the fish by specific location. An example for the Pacific coastal area is reference 47 of this manual.

APPENDIX 6

Salt Treatment for Sturgeon Broodstock and Large Fingerlings

A solution made from rock salt is used on sturgeon as a prophylactic treatment to prevent disease and as a treatment for bacterial and fungal infections. Calculation of concentration in parts per thousand (ppt) is based on half the water volume of the tank to be treated.

- Light Treatment: 7.0 ppt to be applied biweekly or monthly, or as a first bath when (Prophylactic) serious bacterial or fungal infections occur.
- Moderate Treatment: 10.0 ppt to be applied once a day for three consecutive days for light bacterial or fungal infections.
- Heavy Treatment: 15.0 ppt to be applied after an initial light treatment. It is applied once a day for 3 consecutive days for serious bacterial and fungal infections.

Procedure: Drain the tank to one-half volume, shut down the incoming water, and provide maximum aeration. Place the measured amount of salt in a net or mesh bag and dissolve the salt uniformly in the tank. Leave the sturgeon in this bath for 30 minutes. For heavy treatments, watch the fish for signs of stress and provide fresh water if stress occurs. At the end of 30 minutes, initiate water flow at one-half the normal rate until the tank is full, then provide full flow. Often rock salt contains soil. If the water is dirty following the treatment, after 1-2 hours drain the tanks to two-thirds volume and refill.

Salt Treatment for Fry and Sub-Eight-Inch Fingerlings

Hatchery personnel are just now experimenting with salt treatments for young sturgeon. Young sturgeon are sensitive to salt treatments, and relatively strong concentrations can cause stress or death. Some commercial hatcheries have had success treating young sturgeon with low concentrations of salt. The following recommendations are concentrations that have been used successfully. Variations in response of young sturgeon to salt concentrations have been noted among different spawn lots and with different water qualities. The following concentrations are recommended as a baseline to be adjusted as needed, and it is recommended that treatments be initiated with small test lots of fish.

Sac Fry	0.25% salt concentration
2-4" Fingerlings	0.5% salt concentration
4-8" Fingerlings	1.0% salt concentration

APPENDIX 7

Identification of Female White Sturgeon Before Reproductive Migration

Female white sturgeon captured in the bays before their reproductive migration have been identified as such by the condition of the ventral scutes posterior to the anal fin. Ordinarily pronounced and rough, the ventral scutes are nearly flush with the skin and feel relatively smooth when stroked with finger or fingernails. This condition is believed to be due to reabsorption of calcium and other minerals during egg development.

APPENDIX 8

Use of Nitrofurazone as a Disinfectant

Nitrofurazone is a good disinfectant when used as a topical dressing during fish surgery to treat abrasions and other wounds. Veterinarians often recommend direct application of the dry powder form to the area to be treated. Under both field and hatchery conditions, it is hard to control the dry powder because of wind and other factors common to these relatively uncontrolled conditions. Because nitrofurazone is considered carcinogenic, it is especially hazardous if inhaled. For this reason, hatchery personnel prefer to use an aqueous solution to the direct use of the powder form. Although some veterinarians feel that this reduces the effectiveness of nitrofurazone, hatchery personnel have found the aqueous solution to perform quite well in controlling infection in sturgeon under these conditions. Nitrofurazone can be obtained from many fisheries chemical supply houses. *The following recommendations are based on solutions made from the powder form with 9.3% active ingredient (a.i.).*

Preparation of Nitrofurazone as a Topical Disinfectant: Mix 42.0 grams of 9.3% a.i. nitrofurazone in 500 ml of boiled hatchery water. If hatchery water is not available, use distilled water with 0.6 g NaCl to give a 6.0% physiological saline base. The final solution is placed in a wash bottle for ease of application.

APPENDIX 9

Classification of Gametogenic Stages in the White Sturgeon

Stage	Female	Male
1	Differentiated ovary consists of fatty adipocytes, with oogonia and primary oocytes at the periphery of ovigerous fold. Primary oocytes are small (50 μ m in diameter) and contain a large nuclei with condensed chromatin.	Testes are composed of adipose fatty tissue with a thin (3-5 mm) cord of germinal tissue containing dividing spermatogonia, loosely arranged in cysts.
2	At least 50% of ovarian tissue consists of growing oocytes, ranging from 100-250 μ m. Gonial cells are almost absent. Cytoplasm is strongly basophilic and contains large vesicles in the cortex area, staining for carbohydrates. There are numerous nucleoli and often lampbrush chromosomes in the nucleus.	Germinal portion of testis is enlarged (approximately one-third of gland volume) and consists of well differentiated cysts containing primary spermatocytes.
3	Little or no fatty adipocytes remain in the ovary. There are two clutches of germ cells, one as described for stage 2, and another consisting of differentiated oocyte 800-1,200 μ m in diameter. Oocyte cytoplasm is eosinophilic and contains yolk platelets. One- or two- layered zona radiata and two-layered follicular envelope are differentiated. Nucleus with diffused chromatin and small numbers of nucleoli. There is no pigment in the cortex area.	Testes are enlarged, with about one-third of fatty tissue. Cysts contain various meiotic stages, from primary spermatocyte to spermatid. In some, a small number of ripe spermatozoa are present.
4	There are two clutches of oocytes, one as described in stage 2, another represented by large black eggs 3,500-4,000 μ m diameter. Cytoplasm is filled with platelets and oil droplets and contains melanin pigment granules in the cortex area. Envelope consists of two-layered zona radiata and thick gelatinous coat. As follicle ripens, the egg becomes polarized and the enlarged nucleus (germinal vesicle) migrates to the animal pole.	Testes are greatly enlarged, contains little or no adipose tissue. All cysts and ducts are filled with mature spermatozoa.

APPENDIX 10

Incubation Medium

If commercial products (such as L-15 [Leibovitz] with L-Glutamine, Sigma Chemical Company) are not available, a suitable medium can be prepared as follows:

NaCl	-	6.5 g
NaHCO ₃	-	2.0 mg
KCl	-	250.0 mg
CaCl ₂	-	300.0 mg

Dissolve above chemicals in 1.0 L of distilled water. The addition of antibiotics is not required but is recommended. If antibiotics are used, they are added to the above volume as follows:

Penicillin	-	500,000 units
Streptomycin	-	0.25 grams

APPENDIX 11

Suture Materials

Recommended suture materials include a reverse cutting edge, half-circle surgical needle with monofilament or braided polyester suture. The suture material should not be threaded through an eye in the needle, but swedged onto the needle's butt. The incision will heal rapidly, so the suture material should be designed to break down in a few days. A frequently used prepackaged set is Ethicon's Cutting OS-4 Needle (B518) swedged to a 75.0 cm sterile, nonabsorbable polyester suture. The nonabsorbable designation refers to tissue-induced absorption, but the suture material will break down within a few days due to abrasion when the surgeon moves on the bottom of the tank.

APPENDIX 12

Oocyte Maturation

Oocyte maturation can be identified as the breakdown in the oocyte of the nuclear membrane of the germinal vesicle. Germinal vesicle breakdown is the result of a surge in the plasma gonadotropin observed prior to ovulation. Follicular cells are sensitized as a result of the increased amount of gonadotropin and in turn release a steroid maturation hormone which reacts with the oocyte and ultimately, through a chain of intracellular events, induces germinal vesicle breakdown and meiotic cell division.

APPENDIX 13

Surgical Equipment

Surgical equipment for the secondary ovarian examination should include instruments preferred by the individual performing the surgery. The following is a list of instruments and materials used at the UC Davis sturgeon hatchery when this surgery is performed:

- Scalpel, #3 handle, #10 or #15 blade
- Forceps, Adson-Brown tissue
- Forceps, needle (with carbide teeth insets)
- Surgical needle, reversed cutting OS-4, curved (Ethicon)
- Suture material, "Ethibond" green braided polyester #1 (4.0 metric) gauge, nonabsorbable, swedged onto surgical needle

APPENDIX 14

Maturation Steroid Progesterone

All steroids, including progesterone, are insoluble in water and must initially be dissolved in 100% ethyl alcohol. A stock solution of progesterone is prepared by adding 10 mg Progesterone (4-Pregnene-3,20-dione, Sigma Chemical Co.) to 10 ml of 100% ethyl alcohol giving a final concentration of 1.0 mg/ml. Then 0.2 ml of this stock solution is added directly to the 20.0 ml of Ringer's incubation medium in each petri plate, and gently mixed. The final ethyl alcohol concentration in the petri plate is less than 1.0% and will not affect the incubating oocytes.

APPENDIX 15

Spawning Induction Substances

Extracts of fresh or acetone-dried sturgeon pituitary glands have been used to stimulate a spawning response in sturgeon, but its availability is inconsistent and limited. Human chorionic gonadotropin (HCG), commonly used to induce spawning in other fish, has not been used successfully with white sturgeon.

APPENDIX 16

Spawning Induction of Sturgeon with LHRHa

At present, more experience in spawning induction of sturgeon has been gained using acetone-dried common carp pituitary powder (CCP) than with the mammalian gonadotropin (or luteinizing hormone) releasing hormone analogue (LHRHa). LHRHa has been used successfully by commercial breeders, but less is known about the dose-response relationship, and their use is more experimental. This substance is 100% synthetic, at present more experimental, and approximately three times the price of commercially available CCP for an equivalent spawn.

Basis for calculating dose of LHRHa

The total dose for the female is divided into two injections:

Initial dose = 10% of the total calculated dose
Resolving dose = 90% of the calculated dose

The males receive a single injection of the total dose at the time of the females' resolving dose.

Females - 0.1 mg/kg body weight
Males - 0.03 mg/kg body weight

The inducing hormone LHRHa readily dissolves in sterile distilled water or physiological saline and does not require mixing in a tissue homogenizer. It is sold in preweighed quantities and is easily reconstituted using a syringe and needle.

Since the quantities and injection volumes involved are so much less with LHRHa than with CCP, a 1.0 cc syringe ("tuberculin") is more suitable than the 3.0-5.0 cc syringes recommended for use with CCP.

APPENDIX 17

Cryopreservation

The technology for cryopreservation of fish and invertebrate gametes is being researched at a number of institutions, and limited success has been achieved. Among the most significant work is being conducted on the cryopreservation of salmonid eggs and sperm. Research is being conducted on the cryopreservation of sturgeon gametes, however, the work is still in its infancy. The ability to cryopreserve gametes would assure preservation of gene stocks that are endangered or threatened and would preserve selected gene lines for commercial production. Commercial hatcheries are interested in the cryopreservation of sturgeon sperm in order to reduce the number of broodstock held in maturation programs.

APPENDIX 18

Mechanical Siltation

Studies have been conducted using an egg incubation design in combination with mechanical fertilization and siltation. When such a system is employed, the milt is added to the water in the head tank, independent of the ultraviolet unit. The silt is placed in an independent siltation sump at a rate of 25.0 ml dry silt per liter of water. The mechanical siltation unit is a closed bypass in the normally open incubation system, in which silted water is allowed to recirculate through the incubation jars. Recirculation is accomplished by connecting the siltation input pipes to their respective adapters leading to the incubation jars. Silt suspension is pumped through the incubation jar at a rate of 3-4 L/min. De-adhesion occurs in the jar. Silted water then passes over the jars' lips into the siltation sump, where it is recirculated through the system. Once the treatment is completed (approximately 60 minutes), the water distribution valves are closed, input pipes are removed from the siltation sump, jar lip extensions are placed over the head tank sump, and nonsilted water is reconnected and allowed to flow through the system.

Batches of eggs fertilized concomitantly with mechanical de-adhesion show low embryonic survival. Manual fertilization followed by mechanical siltation produces survival rates similar to those with manual fertilization and siltation. However, most hatchery personnel prefer manual fertilization and de-adhesion as they believe the combination provides better control over these events.

APPENDIX 19

Fry Rations Combined with Natural Foods

Combinations of natural foods and rations have been used with success. This process combines use of *Tubifex* worms with a moist ration at the initiation of feeding and then slow elimination of the natural food until the fish have been entirely weaned to the moist diet. In the preparation of the natural food, tubificid worms are chopped into small, 1.0-3.0 mm pieces before feeding to the fry. As soon as possible, the sturgeon fingerlings are weaned to a dry ration.

REFERENCES



GENERAL REFERENCES

1. Adams, L. A. 1942. Age determination and rate of growth in *Polyodon spathula* by means of the growth rings of the otoliths and dentary bones. *Am Wildl and Nat* 28(3):617-30.
2. Anderson, E. R. 1984. Artificial propagation of lake sturgeon, *Acipenser fulvescens* (Rafinesque), under hatchery conditions in Michigan. Fish Res Rep No. 1898. Fish Div Michigan Dep Nat Res. 32 pp.
3. Anonymous. 1954. 152-year-old lake sturgeon caught in Ontario. *Comm Fish Rev* 16(9):28.
4. Artyukin, Ye. N., A. D. Sukhoparova, and L. G. Fimukhina. 1978. The gonads of the sturgeon, *Acipenser guldenstadtii*, in the zone below the dam of the Volgograd water engineering system. *J Ichthyol* 18(6):912-23.
5. Astakhova, T. V. and K. V. Martino. 1966. Measures for the control of fungous diseases of the eggs of sturgeons in fish hatcheries. *Probl Ichthyol* 8(2):261-8.
6. Badenko, L. V., G. G. Korniyenko, V. P. Chikhacheva, and L. A. Altukhova. 1981. Methods for evaluating the quality of sturgeon spawners (as exemplified in the sevryuga, *Acipenser stellatus*) from the Kuban River. *J Ichthyol* 21(1):96-103.
7. Bajkov, A. D. 1951a. A preliminary report on the Columbia River sturgeon. *Oregon Fish Comm Res Briefs* 2(2):3-10.
8. ——— 1951b. Migration of the white sturgeon (*Acipenser transmontanus*) in the Columbia River. *Oregon Fish Comm Res Briefs* 3(2):8-21.
9. Baker, J. P. 1980. The distribution, ecology, and management of the lake sturgeon (*Acipenser fulvescens* Rafinesque) in Michigan. Fish Res Rep No. 1883. Fish Div, Michigan Dep Nat Res. 95 pp.
10. Ballard, W. W. 1976. The sturgeon business in the Soviet Union. Pages 8-14 of unpublished exchange visit report made to the National Academy of Sciences, Committee on International Relations, August 1976. Available from: W. W. Ballard, Dartmouth College, Hanover, NH.
11. Ballard, W. W. and A. S. Ginsburg. 1980. Morphogenetic movements in acipenserid embryos. *J Exp Zool* 213(1):69-103.
12. Ballard, W. W. and R. G. Needham. 1964. Normal embryonic stages of *Polyodon spathula* (Walbaum). *J Morphol* 114:465-78.
13. Barannikova, I. A., A. A. Boyev, G. A. Zenkevich, Z. M. Latse, and L. P. Soltitskaya. 1981. Efficacy of purified sturgeon gonadotropin and other pituitary preparations for ovary maturation in the Russian sturgeon, *Acipenser guldenstadtii*. *J Ichthyol* 21(4):114-21.
14. Bardach, J. E., J. H. Ryther, and W. O. McLaren. 1972. Culture of sturgeon, in *Aquaculture: the Farming and Husbandry of Freshwater and Marine Organisms*. John Wiley and Sons, New York, p. 520-7.
15. Bath, D. W. and J. M. O'Connor. 1981. Development and identification of larval Atlantic sturgeon (*Acipenser oxyrinchus*) and shortnose sturgeon (*A. brevirostrum*) from the Hudson River estuary, New York. *Copeia* 3:711-7.
16. Becker, C. D. 1980. Haematozoa from resident and anadromous fishes of the central Columbia River: a survey. *Can J Zool* 58(3):356-62.
17. Beer, K. E. 1981. Embryonic and larval development of white sturgeon (*Acipenser transmontanus*). Unpublished Master's Thesis, Univ Calif, Davis, CA. 93 pp.
18. ——— 1983. Commercial feasibility of white sturgeon culture. Paper presented at the 113th Ann Meeting Am Fish Soc, Milwaukee, WI, 16-20 August 1983.
19. Binkowski, F. P. 1983. Cage culture of lake sturgeon and related feeding studies. Paper presented at the 113th Ann Meeting Am Fish Soc, Milwaukee, WI, 16-20 August 1983.
20. Binkowski, F. P. and D. G. Czeskleba. 1980. Methods and techniques for collecting and culturing lake sturgeon eggs and larvae. Paper presented at the 10th Ann Meeting World Mariculture Soc, New Orleans, LA, 5-8 March 1980.

21. Binkowski, F. P. and S. I. Doroshov, eds. 1985. North American sturgeons: biology and aquaculture potential. Dr. W. Junk Publishers, Dordrecht. 163 pp.
22. Borodin, N. A. 1920. Artificial propagation of sturgeon, Part 2. Artificial propagation of sturgeon in Russia. Appendix III to the Rep U.S. Comm of Fisheries for 1919, pages 6-7. Bur Fish Doc No. 880. Dep Comm Bur Fisheries, Washington, DC.
23. Borodin, N. A. 1925. Biological observations on the Atlantic sturgeon *Acipenser sturio*. Trans Am Fish Soc 55:184-90.
24. Brice, J. J. 1898. A manual of fish culture based on the method of the U.S. Commission of Fish & Fisheries. Rep U.S. Comm Fish & Fisheries 23:189-91.
25. Brown, C. J. D. 1955. A record-size pallid sturgeon, *Scaphirhynchus albus*, from Montana. Copeia 1:55.
26. Buckley, J. and B. Kynard. 1981. Spawning and rearing of shortnose sturgeon from the Connecticut River. Prog Fish-Culturist 43(2):74-6.
27. ——— 1985. Habitat use and behavior of pre-spawning and spawning shortnose sturgeon, *Acipenser brevirostrum*, in the Connecticut River, in N Am Sturgeons: Biol Aqua Potential. F. P. Binkowski and S. I. Doroshov, eds. Dr. W. Junk Publishers, Dordrecht, p. 111-8.
28. Buddington, R. K. and J. P. Christofferson. 1985. Digestive and feeding characteristics of the chondrosteans, in N Am Sturgeons: Biol Aqua Potential. F. P. Binkowski and S. I. Doroshov, eds. Dr. W. Junk Publishers, Dordrecht, p. 31-42.
29. Buddington, R. K. and S. I. Doroshov. 1984. Feeding trials with hatchery produced white sturgeon juveniles (*Acipenser transmontanus*). Aquaculture 36:237-43.
30. ——— 1986. Development of digestive secretions in white sturgeon juveniles (*Acipenser transmontanus*). Comp Biochem Physiol. Vol 83A(2):233-8.
31. Burr, B. M. 1980. *Polyodon spathula* (Walbaum), paddlefish, in Atlas of N Am Freshwater Fishes. D. S. Lee, et al., eds. N Carolina State Mus Nat Hist, Raleigh, NC, p. 45-6.
32. Carlander, K. D. 1969. Handbook of freshwater fishery biology, Vol. 1. Iowa State Univ Press, Ames, IA. 752 pp.
33. Carlson, D. M. 1983. Life histories of river populations of shovelnose sturgeon and pallid sturgeon. Paper presented at the 113th Ann Meeting Am Fish Soc, Milwaukee, WI, 16-20 August 1983.
34. Carlson, D. M., W. L. Pflieger, L. Trial, and P. S. Haverland. 1985. Distribution, biology and hybridization of *Scaphirhynchus albus* and *S. platyrhynchus* in the Missouri and Mississippi Rivers in N Am Sturgeons: Biol Aqua Potential. F. P. Binkowski and S. I. Doroshov, eds. Dr. W. Junk Publishers, Dordrecht, p. 51-60.
35. Cech, J. J., Jr., S. J. Mitchell, and T. E. Wragg. 1984. Comparative growth of juvenile white sturgeon and striped bass: effects of temperature and hypoxia. Estuaries 7(1):12-8.
36. Chadwick, H. K. 1959. California sturgeon tagging studies. Calif Fish Game 45(4):297-301.
37. Cherr, G. N. and W. H. Clark, Jr. 1980. Sperm passage through the micropyles and egg activation in the white sturgeon, *Acipenser transmontanus*. Am Zool 20:876. (abstract)
38. ——— 1982. Fine structure of the envelope and micropyles in the eggs of the white sturgeon, *Acipenser transmontanus* Richardson. Develop Growth Differ 24(4):341-52.
39. ——— 1983. Artificial and natural activation of sperm from two acipenserid fish—a demonstration of species specificity. Paper presented at the 113th Ann Meeting Am Fish Soc, Milwaukee, WI, 16-20 August 1983.
40. ——— 1984a. Jelly release in the eggs of the white sturgeon, *Acipenser transmontanus*: an enzymatically mediated event. J Exp Zool 230:145-9.
41. ——— 1984b. An acrosome reaction in sperm from the white sturgeon, *Acipenser transmontanus*. J Exp Zool 232:129-39.
42. ——— 1985. Gamete interaction in the white sturgeon *Acipenser transmontanus*: a morphological and physiological review, in N Am Sturgeons: Biol and Aqua Potential. F. P. Binkowski and S. I. Doroshov, eds. Dr. W. Junk Publishers, Dordrecht, p. 11-22.

43. Christofferson, J. P. 1983. Preliminary investigations of the chemical control of feeding behavior in juvenile *Acipenser transmontanus*. Paper presented at the 113th Ann Meeting Am Fish Soc, Milwaukee, WI, 16-20 August 1983.
44. Clemens, W. A. and G. V. Wilby. 1961. Fishes of the Pacific Coast of Canada. Bull 68. Fish Res B Can. 443 pp.
45. Cochnauer, T. G. 1981. River and stream investigations—Snake River fisheries investigations. Survey status of white sturgeon populations in the Snake River, Bliss Dam to C. J. Strike Dam. Perf Rep, Proj F-73-R-3(4) 7-2. Idaho Dep of Fish and Game, Boise, ID. 5 pp.
46. Cochnauer, T. G., J. R. Lukens, and F. E. Partidge. 1985. Status of white sturgeon, *Acipenser transmontanus*, in Idaho, in N Am Sturgeons: Biol and Aqua Potential. F. P. Binkowski and S. I. Doroshov, eds. Dr. W. Junk Publishers, Dordrecht, p. 127-34.
47. Cuanang, A. 1984. San Francisco Bay Sturgeon. Angler Pub. P.O.B. 12155, Oakland, CA 94604. 89 pp.
48. Cuerrier, J.-P. 1951. The use of pectoral fin rays to determine age of sturgeon and other species of fish. Can Fish Cult 11:10-18.
49. ——— 1966. L'esturgeon de lac, *Acipenser fulvescens* Raf. de la region du Lac St. Pierre au cours de la periode du frai. Naturaliste Canadien 93:279-334.
50. Cuerrier, J.-P. and G. Roussow. 1951. Age and growth of lake sturgeon from Lake St. Francis, St. Lawrence River. Report on material collected in 1947. Can Fish Cult 10:17-29.
51. Czeskleba, D. G., S. AveLallemant, and T. F. Thuemler. 1985. Artificial spawning and rearing of lake sturgeon, *Acipenser fulvescens*, in Wild Rose State Fish Hatchery, Wisconsin, 1982-83, in N Am Sturgeons: Biol and Aqua Potential. F. P. Binkowski and S. I. Doroshov, eds. Dr. W. Junk Publishers, Dordrecht, p. 79-86.
52. Dadswell, M. J. 1979. Biology and population characteristics of the shortnose sturgeon, *Acipenser brevirostrum* LeSueur 1818 (Osteichthyes: Acipenseridae), in the Saint John River Estuary, New Brunswick, Can. Can J Zool 57(11):2186-210.
53. Dean, B. 1893. Notes on the spawning conditions of the sturgeons. Zool Anz 16:473-5.
54. ——— 1894. Recent experiments in sturgeon hatching on the Delaware River. Bull U.S. Fish Comm 13 (1893):335-9.
55. Dees, L. T. 1961. Sturgeons. Fishery Leaflet 526. U.S. Dep Inter, Washington, DC. 8 pp.
56. Detlaf, T. A. and S. I. Davodova. 1979. The effect of triiodothyronine on the maturation of the oocytes of the sevruga, *Acipenser stellatus*, under the influence of the gonadotropic hormones. J Ichthyol 19(3):105-10.
57. Detlaf, T. A. and A. S. Ginzburg. 1951. Analysis of mortalities in eggs of sevruga during incubation period (in Russian). Trans Inst Morphol Zhivotn Akd Nauk SSSR 5:184-201.
58. ——— 1954. The embryonic development of sturgeons (Russian sturgeon, sevruga, and beluga) in connection with the question of their artificial propagation (in Russian). Acad Sci Press, Moscow, U.S.S.R. 204 pp.
59. ——— 1963. Acrosome reaction in sturgeons and the role of calcium ions in the union of gametes. Doklady An SSR 153(6):1461-4.
60. Detlaf, T. A., A. S. Ginzburg, and I. O. Shmal'gauzen. 1981. Development of sturgeon: egg maturation, fertilization, embryonic and prelarval development (in Russian). Nauka Press, Moscow, U.S.S.R. 224 pp.
61. Disler, N. N. 1960. Lateral line sense organs and their importance in fish behavior. Translated from Russian, Israel Program Sci Trans, 1971.
62. Dorshov, S. I. 1983. Sturgeon culture. Paper presented at the 113th Ann Meeting Am Fish Soc, Milwaukee, WI, 16-20 August 1983.
63. 1985. Biology and culture of sturgeon, *Acipenseriformes* in Recent Advances in Aquaculture, volume 2. J. F. Muir and F. J. Roberts, eds. Westview Press, p. 251-75.
64. Doroshov, S. I., W. H. Clark, Jr., P. B. Lutes, R. L. Swallow, K. E. Beer, A. B. McGuire, and M. D. Cochran. 1983. Artificial propagation of the white sturgeon, *Acipenser transmontanus* Richardson. Aqua 32:93-104.

65. Doroshov, S. I. and P. B. Lutes. 1984. Preliminary data on the induction of ovulation in white sturgeon (*Acipenser transmontanus* Richardson). *Aqua* 38:221-7.
66. Dovel, W. L. 1978. Biology and management of shortnose and Atlantic sturgeon of the Hudson River. Performance Report, Project AFS-9-R. NY State Dep of Environ Conserv. 181 pp.
67. ——— 1979. The biology and management of the shortnose and Atlantic sturgeon of the Hudson River. Final Report, Project AFS-9-R. NY State Dep Environ Conserv. 45 pp.
68. Dragomirov, N. I. 1953. Development of yolk-sac sevryuga larvae. *Proc Instit Animal Morphol* 3:244-63.
69. Eddy, S. and J. Underhill. 1957. How to Know the Freshwater Fishes. Wm. C. Brown C., Dubuque, IA. 253 pp.
70. Eschmeyer, W. N., E. S. Herald, and H. Hammann. 1983. A Field Guide to the Pacific Coast Fishes of North America. Houghton-Mifflin, Boston, MA. 336 pp.
71. Fedorova, L. S. 1976. Physiological and biochemical characteristics of the reproductive products and larvae of sturgeons during artificial rearing. *J Ichthyol* 16(3):427-36.
72. Folz, D. J., D. G. Czeskleba, and T. F. Thuemler. 1983. Artificial spawning of lake sturgeon in Wisconsin. *Prog Fish-Culturist* 45(4):231-3.
73. Folz, D. J. and L. S. Meyers. 1985. Management of the lake sturgeon, *Acipenser fulvescens*, population in the Lake Winnebago system, Wisconsin, in *N Am Sturgeons: Biol Aqua Potential*. F. P. Binkowski and S. I. Doroshov, eds. Dr. W. Junk Publishers, Dordrecht. p. 135-46.
74. Fried, S. M. and J. D. McCleave. 1973. Occurrence of the shortnose sturgeon (*Acipenser brevirostrum*), an endangered species, in Montsweag Bay, Maine. *J Fish Res Bd Can* 30:563-4.
75. Fry, D. J. 1973. Anadromous fishes of California. Calif Dep Fish and Game. 111 pp.
76. Galbreath, J. L. 1985. Status, life history, and management of Columbia River white sturgeon, *Acipenser transmontanus*, in *N Am Sturgeons: Biol Aqua Potential*, F. P. Binkowski and S. I. Doroshov, eds. Dr. W. Junk Publishers, Dordrecht, p. 119-26.
77. Galligan, J. P. 1960. History of the Connecticut River sturgeon fishery. *Conn Wildl Cons Bull* 6(1):5-6.
78. Gerbilsky, N. L. 1972. Biological foundations and methods of sturgeon artificial reproduction, in connection with the construction of hydropower plants (in Russian). Tr Tzentr Lab Vosproiz-Vodstvu Rybn Zapasov Glavrybrod LGU:48-70.
79. Gershanovich, A. D. 1983. Factors determining variations in growth rate and size distribution in groups of young paddlefish, *Polyodon spathula* (Polyodontidae). *J Ichthyol* 23(4):56-61.
80. Gilbert, B. 1981. End of a long journey for spoonbill cat. *Audubon* 83(2):66-71.
81. Ginzburg, A. S. 1957. The time when sperm makes contact with the egg during the fertilization process in sturgeon. *Doklady Biol Sci* 115:646-9.
82. ——— 1961. The block to polyspermy in sturgeon and trout with special reference to the role of cortical granules (alveoli). *J Embryol Exp Morphol* 9(1):173-90.
83. Ginzburg, A. S. and T. A. Detlaf. 1969. The development of sturgeons (in Russian). Nauka Press, Moscow, U.S.S.R.
84. Ginzburg, A. S., S. E. Zubova, and L. A. Filatova. 1963. A rational technique for the insemination of sturgeon eggs (in Russian) in *Sturgeon Management in the U.S.S.R.* E. N. Pavlovsky, ed. Moscow, U.S.S.R., p. 47-55.
85. Goncharov, B. F. 1976. Physiological state of the follicles in stellate sturgeon during the spawning migration (in Russian), in *3rd All Union Conference on the Physiological Ecology of Fish*, Vol. II. Publishing House Naukova Dumka, Kiev, U.S.S.R., p. 139-40.
86. Gordienko, O., P. Aphonich, and E. Soldatova. 1970. Tank rearing of sturgeon fry and fingerlings (in Russian). *Proc All-Union Res Instit of Mar Fish and Oceanog* 74.
87. Gorham, S. W. and D. E. McAllister. 1974. The shortnose sturgeon, *Acipenser brevirostrum*, in the Saint John River, New Brunswick, Canada, a rare and possibly endangered species. *Syllogeus* 5:1-18.
88. Greely, J. R. 1937. Fishes of the area with an annotated list, in *A Biological Survey of the Lower Hudson Watershed*. Supplement, 26th Annu Rep. NY Conserv Dep 11:45-103.

89. Gruchy, C. G. and B. Parker. 1980. *Acipenser brevirostrum* LeSueur, shortnose sturgeon, in Atlas of North American Freshwater Fishes, D. S. Lee, et al., eds. N Carolina State Mus of Nat Hist, Raleigh, NC, p. 38-9.
90. ——— 1980. *Acipenser fulvescens* Rafinesque, lake sturgeon, in Atlas of North American Freshwater Fishes. N Carolina State Mus of Nat Hist, Raleigh, NC, p. 39-40.
91. ——— 1980. *Acipenser oxyrhynchus* Mitchell, Atlantic sturgeon, in Atlas of North American Freshwater Fishes. N Carolina State Mus Nat Hist, Raleigh, NC, p. 41-2.
92. Gun'ko, A. F. 1974. The biological background of a new aspect of the basic outline of the hatchery rearing of sturgeons (HRS). J Ichthyol 14(6):986-9.
93. Harkness, W. J. K. 1923. The rate of growth and the food of the lake sturgeon (*Acipenser rubicundus* LeSueur). Univ Toronto Studies, Biol S 24, Pub Ontario Fish Res Lab 18:15-42.
94. Harkness, W. J. K. and J. R. Dymond. 1961. The lake sturgeon, the history of its fishery and problems of conservation. Ontario Dep Lands and Forests, Ontario, Can. 121 pp.
95. Hart, J. L. 1973. Pacific fishes of Canada. Bull 180. Fish Res Bd Can, Ottawa, Canada. 740 pp.
96. Haynes, J. M., R. H. Gray, and J. C. Montgomery. 1978. Seasonal movements of white sturgeon (*Acipenser transmontanus*) in the mid-Columbia River. Trans Am Fish Soc 107(2):275-80.
97. Haynes, J. M. and R. H. Gray. 1981. Diet and seasonal movements of white sturgeon, *Acipenser transmontanus*, in the mid-Columbia River. Fish Bull 79(2):367-70.
98. Held, J. W. 1969. Some early summer foods of the shovelnose sturgeon in the Missouri River. Trans Am Fish Soc 98(3):514-7.
99. Helms, D. R. 1974. Age and growth of the shovelnose sturgeon, *Scaphirhynchus platyrhynchus* (Rafinesque), in the Mississippi River. Proc Iowa Acad Sci 81(2):73-5.
100. Houser, A. 1965. Growth of paddlefish in Fort Gibson Reservoir, Oklahoma. Trans Am Fish Soc 94(1):91-2.
101. Houser, A. and M. Bross. 1959. Observations on growth and reproduction of the paddlefish. Trans Am Fish Soc 88(1):50-2.
102. Huff, J. A. 1975. Life history of Gulf of Mexico sturgeon, *Acipenser oxyrhynchus desotoi*, in Suwannee River, Florida. Florida Marine Res Pub. No. 16. Marine Res. Lab., Florida Dep Nat Res, St. Petersburg, FL. 32 pp.
103. Jones, P. W., F. D. Martin, and J. O. Hardy. 1978. Development of fishes of the mid-Atlantic Bight, an atlas of egg, larval and juvenile stages. Volume 1: Acipenseridae through Ictaluridae. Report FWS/OBS-78/12. Biological Services Program, U.S. Fish and Wildlife Service. 366 pp.
104. Kallemeyn, L. 1983. Status of the pallid sturgeon, *Scaphirhynchus albus*. Fisheries 8(1):3-9.
105. Kirsch, P. H. and M. W. Fordice. 1889. A review of the American species of sturgeons. Proc Acad Natl Sci Philadelphia 41:245-57.
106. Klyashtorin, L. B. 1976. The sensitivity of young sturgeons to oxygen deficiency. J Ichthyol 16(4):677-82.
107. ——— 1981. The ability of sturgeons (Acipenseridae) to regulate gas exchange. J Ichthyol 21(3):141-4.
108. Knox, J. D. and M. J. Dadswell. 1980. An annotated bibliography on reproduction and early life history of sturgeon (Osteichthyes: Acipenseridae) with reference to fish passage and artificial culture in the U.S.S.R. Northeast Util Serv Co, Hartford, CT. 114 pp.
109. Kohlhorst, D. W. 1976. Sturgeon spawning in the Sacramento River in 1973, as determined by distribution of larvae. Calif Fish Game 62(1):32-40.
110. ——— 1978. Effects of first pectoral fin ray removal on survival and estimated harvest rate of white sturgeon in the Sacramento-San Joaquin estuary. Calif Fish Game 64(3):173-7.
111. ——— 1980. Recent trends in the white sturgeon population in California's Sacramento-San Joaquin estuary. Calif Fish Game 66(4):210-9.
112. Kohlhorst, D. W., L. W. Miller, and J. J. Orsi. 1980. Age and growth of white sturgeon collected in the Sacramento-San Joaquin estuary, California: 1965-1970 and 1973-1976. Calif Fish Game 66(2):83-95.
113. Kowtal, G. V., W. H. Clark, Jr., and G. N. Cherr. 1986. Elimination of adhesiveness in eggs from the white sturgeon, *Acipenser transmontanus*: chemical treatment of fertilized eggs. Aquaculture 55:139-43.

114. Kozm, N. I. 1964. Artificial reproduction of sturgeons in the U.S.S.R. (in Russian). Proc All Union Res Instit Mar Fish Oceanog 5:21-58.
115. Kravushkina, L. S. 1957. The histology of the digestive system of sturgeon larvae at different developmental stages. Doklady Biol Sci 177:966-8.
116. Kravushkina, L. S. and S. N. Moiseyenko. 1977. Functional characteristics of osmoregulation in ecologically different species of sturgeons (Acipenseridae) in a hypertonic environment. J Ichthyol 17(3):441-7.
117. Krivobok, M. N. and A. Ya. Storozhuk. 1970. The effect of the size and age of Volga sturgeon on the weight and chemical composition of mature eggs. J Ichthyol 10(6):761-5.
118. Latimore, R. W. 1950. Gametogenesis of *Polyodon spathula* (Walbaum): a basis for regulation of the fishery. Copeia 2:116-24.
119. Leach, G. C. 1920. Artificial propagation of sturgeon, part 1. Review of sturgeon culture in the United States. Appendix III to the Report of the U.S. Commissioner of Fisheries for 1919, pages 3-5. Bur of Fish, Doc No. 880. Dep Com Bur of Fish, Washington, DC.
120. Lee, D. S. 1980a. *Acipenser medirostris* Ayres, green sturgeon, in Atlas of North American Freshwater Fishes. D. S. Lee, et al., eds. N Carolina State Mus Nat Hist, Raleigh, NC, p. 40-1.
121. — 1980b. *Acipenser transmontanus* Richardson, white sturgeon, in Atlas of North American Freshwater Fishes. D. S. Lee, et al., eds. N Carolina State Mus Nat Hist, Raleigh, NC, p. 42-3.
122. — 1980c. *Scaphirhynchus albus* (Forbes and Richardson), pallid sturgeon, in Atlas of North American Freshwater Fishes. D. S. Lee, et al., eds. N Carolina State Mus Nat Hist, Raleigh, NC, p. 43-4.
123. — 1980d. *Scaphirhynchus platyrhynchus* (Rafinesque), shovelnose sturgeon, in Atlas of North American Freshwater Fishes. D. S. Lee, et al., eds. N Carolina State Mus Nat Hist, Raleigh, NC, p. 44-5.
124. Land, J. G., III. 1968. A survey of the sturgeon fishery of South Carolina. Contribution 47. Bears Bluff Labs, Wadamalaw Island, SC. 27 pp.
125. Lindberg, J. C. and S. I. Doroshov. 1986. Effect of diet switch between natural and prepared foods on growth and survival of white sturgeon juveniles. Trans Am Fish Soc 115:166-71.
126. Lutes, P. B. 1984. Ovarian maturation and induced spawning in the white sturgeon (*Acipenser transmontanus* Richardson). Unpublished Ph.D. thesis, Univ Calif, Davis. 80 pp.
127. — 1985. Oocyte maturation in white sturgeon, *Acipenser transmontanus*: some mechanisms and applications, in N Am Sturgeons: Biol Aqua Potential. F. P. Binkowski and S. I. Doroshov, eds. Dr. W. Junk Publishers, Dordrecht, p. 87-92.
128. Lutes, P. B. and S. I. Doroshov. 1983. Spawning induction and hatchery procedure for the white sturgeon, *Acipenser transmontanus*. Paper presented at the 113th Ann Meeting Am Fish Soc, Milwaukee, WI, 16-20 August 1983.
129. Magnin, E. 1959. Repartition actuelle des Acipenserides. Rev Trav Inst Pech Marit 23(3):277-85.
130. — 1962. Recherches sur la systematique et la biologie des Acipenserides *Acipenser sturio* L., *Acipenser oxyrhynchus* Mitchill, et *Acipenser fulvescens* Rafinesque. Annales de la Station Centrale d'Hydrobiologie Appliquee (Paris) 9:8-242.
131. — 1963. Notes sur la repartition, la biologie et particulierement la croissance de l'*Acipenser brevirostris* LeSueur 1817. Naturaliste Canadien 90:87-96.
132. — 1964. Croissance en longueur de trois esturgeons d'Amerique du Nord: *Acipenser oxyrhynchus* Mitchill, *Acipenser fulvescens* Rafinesque et *Acipenser brevirostris* LeSueur. Verh Int Verein Theor Angew Limnol 15:968-74.
133. — 1965. Croissance de l'esturgeon *Acipenser fulvescens* vivant dans le bassin hydrographique de la riviere Nottaway, tributaire de la baie James. Naturaliste Canadien 92(8-9):193-204.
134. — 1966a. Recherches sur les cycles de reproduction des esturgeons *Acipenser fulvescens* de la riviere Nottaway, tributaire de la baie James. Verh Int Verein Theor Angew Limnol 16:1018-24.
135. — 1966b. Quelques donnees biologiques sur la reproduction des esturgeons *Acipenser fulvescens* Raf. de la riviere Nottaway, tributaire de la baie James. Can J Zool 44(2):257-63.

136. ——— 1977. Croissance, regime alimentaire et fecondite des esturgeons *Acipenser fulvescens* Rafinesque du bassin hydrographique de La Grande Riviere (Quebec). *Naturaliste Canadien* 104:419-27.
137. Magnin, E. and G. Beaulieu. 1960. Deplacements des esturgeons (*Acipenser transmontanus* et *Acipenser oxyrinchus*) du Fleuve Saint-Laurent d'apres les donnees du marquage. *Naturaliste Canadien* 87(11):237-52.
138. ——— 1963. Etude morphometrique comparee de l'*Acipenser oxyrinchus* Mitchill du Saint-Laurent et de l'*Acipenser sturio* Linne de la Gironde. *Naturaliste Canadien* 90:5-38.
139. Magnin, E. and P. P. Harper. 1970. La nourriture des esturgeons *Acipenser fulvescens* de la riviere Nottaway, tributaire de la baie James. *Naturaliste Canadien* 97:73-85.
140. Manea, G. 1969. Methods for artificial spawning of sturgeons (Acipenseridae) and hatching of fry. *Revista Italiana de Piscicoltura e Ittio Patologia A. IV-N.4:81-6.*
141. Markov, K. P. 1975. Scanning electron microscope study of the microstructure of the egg membrane in the Russian sturgeon (*Acipenser guldenstadti*). *J Ichthyol* 15(5):739-49.
142. ——— 1978. Adhesiveness of egg membranes in sturgeons (Family Acipenseridae). *J Ichthyol* 18(3):437-46.
143. McEnroe, M. and J. J. Cech, Jr. 1985. Osmoregulation in juvenile and adult white sturgeon, *Acipenser transmontanus*, in *N Am Sturgeons: Biol Aqua Potential*. F. P. Binkowski and S. I. Doroshov, eds. Dr. W. Junk Publishers, Dordrecht, p. 23-30.
144. McGuire, A. B. 1979. The big fish: restoring California's sturgeon population. *Calif Agri* 33(10):4-6.
145. McKechnie, R. J. and R. B. Fenner. 1971. Food habits of white sturgeon, *Acipenser transmontanus*, in San Pablo and Suisun Bays, CA. *Calif Fish Game* 57(3):209-12.
146. Mehan, W. E. 1909. Experiments in sturgeon culture. *Trans Am Fish Soc* 39:85-91.
147. Meyer, F. P. and J. H. Stevenson. 1962. Studies on the artificial propagation of the paddlefish. *Prog Fish-Culturist* 24(2):65-7.
148. Michaletz, P. H., C. F. Rabeni, W. W. Taylor, and T. R. Russell. 1982. Feeding ecology and growth of young-of-the-year paddlefish in hatchery ponds. *Trans Am Fish Soc* 111(6):700-9.
149. Miller, L. W. 1972a. White sturgeon population characteristics in the Sacramento-San Joaquin estuary as measured by tagging. *Calif Fish Game* 58(2):94-101.
150. ——— 1972b. Migrations of sturgeon tagged in the Sacramento-San Joaquin estuary. *Calif Fish Game* 58(2):102-6.
151. ——— 1972c. White sturgeon, in *Ecological Studies of the Sacramento-San Joaquin Estuary*. Report No. 8. J. E. Skinner, compiler. Delta Fish & Wildlife Protection Study, Calif Dep Fish Game, p. 54-6.
152. Milstein, V. V. 1972. Sturgeon Culture (in Russian). *Pischevaya Promyslennost*, Moscow. 129 pp.
153. Monaco, G., R. K. Buddington, and S. I. Doroshov. 1981. Growth of white sturgeon (*Acipenser transmontanus*) under hatchery conditions. *J World Maricul Soc* 12(1):113-21.
154. Monaco, G. and S. I. Doroshov. 1983. Mechanical de-adhesion and incubation of white sturgeon eggs (*Acipenser transmontanus* Richardson). *Aqua* 35:117-23.
155. Moos, R. E. and J. C. Schmulbach. 1983. Extended reproductive cycle and spawning success of shovelnose sturgeon in the Missouri River, South Dakota. Paper presented at the 113th Ann Meeting Am Fish Soc, Milwaukee, WI, 16-20 August 1983.
156. Moyle, P. B. 1976. *Inland Fishes of California*. Univ Calif Press, Berkeley, CA. 405 pp.
157. Murawski, S. A. and A. L. Pacheco. 1977. Biological and fisheries data on Atlantic sturgeon, *Acipenser oxyrinchus* (Mitchill). Technical Series Report No. 10. Nat Marine Fish Serv, Highland, NJ. 69 pp.
158. Needham, R. G. 1965. Spawning of paddlefish induced by means of pituitary material. *Prog Fish-Culturist* 27(1):13-9.
159. Parks, N. B. 1978. The Pacific Northwest commercial fishery for sturgeon. *Mar Fish Rev* 40(7):17-20.
160. Post, H. 1890. The sturgeon, some experiments in hatching. *Trans Am Fish Soc* 19:36-40.

161. Potts, W. T. W. and P. P. Rudy. 1972. Aspects of osmotic and ionic regulation in the sturgeon. *J Exp Biol* 56:703-15.
162. Priegel, G. R. 1973. Lake sturgeon management on the Menominee River. Tech Bull No. 67, Wisconsin Dep Nat Res, Madison, WI. 20 pp.
163. Priegel, G. R. and T. L. Wirth. 1971. The lake sturgeon, its life history, ecology and management. Pub 240-70. Wisconsin Dep Nat Res. 19 pp.
164. ——— 1975. Lake sturgeon harvest, growth and recruitment in Lake Winnebago, Wisconsin. Tech Bull No. 83. Wisconsin Dep Nat Res. 25 pp.
165. ——— 1978. Lake sturgeon populations, growth, and exploitation in Lakes Polygan, Winneconne and Lake Butte des Morts, Wisconsin. Tech Bull No. 107. Wisconsin Dep Nat Res, Madison, WI.
166. Probst, R. T. and E. L. Cooper. 1955. Age, growth, and production of the lake sturgeon (*Acipenser fulvescens*) in the Lake Winnebago region, Wisconsin. *Trans Am Fish Soc* 84:207-27.
167. Purkett, C. A., Jr. 1961. Reproduction and early development of the paddlefish. *Trans Am Fish Soc* 90(2):125-9.
168. ——— 1963a. Artificial propagation of paddlefish. *Prog Fish-Culturist* 25(1):31-3.
169. ——— 1963b. The paddlefish fishery of the Osage River and the Lake of the Ozarks, Missouri. *Trans Am Fish Soc* 92(3):239-44.
170. Pycha, R. L. 1956. Progress report on white sturgeon studies. *Calif Fish Game* 42(1):23-35.
171. Rathburn, R. 1894. Embryology of the sturgeon. Rep U.S. Fish Comm for 1893, p. 48-9.
172. Robinson, J. W. 1966. Observations on the life history, movement, and harvest of the paddlefish. *Proc Montana Acad Sci* 26:33-44.
173. Rodman, D. T. 1963. Anesthetizing and air-transporting of young white sturgeon. *Prog Fish-Culturist* 25(2):71-8.
174. Romanycheva, O. D. 1976. The modern condition of the development of the marine sturgeon culturing for commercial purposes and its perspectives. *Proc of the Japan-Soviet Joint Symp Aqua* 5:353-65.
175. Rostlund, E. 1952. Sturgeons, family Acipenseridae, in *Freshwater Fish and Fishing in Native North America*. Vol. IX, Univ Calif. Pub in Geo. Univ Calif Press, Berkeley, CA, p. 10-2.
176. Roussow, G. 1957. Some considerations concerning sturgeon spawning periodicity. *J Fish Res Bd Can* 14(4):553-72.
177. Russell, T. R. 1973. A study of artificial propagation of the paddlefish. Final Report, Project No. F-1-R-21, Study No. S-5. Missouri Dep Conserv, Jefferson City, MO, 16 pp.
178. Ryder, J. A. 1888. On the development of the common sturgeon. *Am Natl* 22:659-60.
179. ——— 1890. The sturgeon and sturgeon industries of the eastern coast of the United States, with an account of experiments bearing upon sturgeon culture. *U.S. Fish Comm Bull* (1888) 8:231-8.
180. Sadow, I. A. and Y. M. Kokhanskaya. 1963. A trough incubator for sturgeon eggs (in Russian). *Rybnoe Khozjastvo* 6.
181. Schreiber, M. R. 1960. Observations on the systematics and food habits of juvenile white sturgeon (*Acipenser transmontanus*) and green sturgeon (*Acipenser medirostris*). *Inland Fisheries Administrative Report* 60-15. Calif Dep Fish Game. 5 pp.
182. ——— 1962. Observations on the food habits of juvenile white sturgeon. *Calif Fish Game* 48(1):79-80.
183. Scott, W. B. and E. J. Crossman. 1973. The sturgeons and paddlefishes—order Acipenseriformes (Chondrostei), in *Freshwater Fishes of Canada*. Bull 184. *J Fish Res Bd Can*, Ottawa, Can, p. 77-100.
184. Semakula, S. N. and P. A. Larkin. 1968. Age, growth, food, and yield of the white sturgeon (*Acipenser transmontanus*) of the Fraser River, British Columbia. *J Fish Res Bd Can* 25(12):2589-602.
185. Shigekawa, K. H. and S. H. Logan. [No Date]. Economic analysis of commercial hatchery production of sturgeon. Unpublished manuscript, Univ Calif, Davis, CA. 28 pp.
186. Smith, T. I. J. 1985. The fishery, biology, and management of Atlantic sturgeon, *Acipenser oxyrinchus*, in *North America in N Am Sturgeons: Bio and Aqua Potential*. F. P. Binkowski and S. I. Doroshov, eds. Dr. W. Junk Publishers, Dordrecht, p. 61-72.

187. Smith, T. I. J. and E. K. Dingly. 1984. Review of biology and culture of Atlantic (*Acipenser oxyrinchus*) and shortnose sturgeon (*A. brevirostrum*). *J World Maricul Soc* 15:210-8.
188. Smith, T. I. J., E. K. Dingley, R. D. Lindsey, S. B. VanSant, R. A. Smiley, and A. D. Stokes. Spawning and culture of shortnose sturgeon, *Acipenser brevirostrum*. *J World Maricul Soc*. In press.
189. Smith, T. I. J., E. K. Dingley, and D. E. Marchette. 1980. Induced spawning and culture of Atlantic sturgeon. *Prog Fish-Culturist* 42(3):147-51.
190. ——— 1981. Culture trials with Atlantic sturgeon, *Acipenser oxyrinchus*, in the USA. *J World Maricul Soc* 12(2):78-87.
191. Smith, T. I. J., D. E. Marchette, and R. A. Smiley. 1982. Life history, ecology, culture and management of the Atlantic sturgeon, *Acipenser oxyrinchus oxyrinchus* Mitchill, in South Carolina. Final Tech Rep Project AFS-9. S Carolina Wild Marine Resources Res Dep, Atlanta, GA. 75 pp.
192. Somkina, N. V. 1974. Physiological considerations affecting the time of release of juvenile sturgeon (*Acipenser guldenstadti* Brandt). *J Ichthyol* 14(4):561-6.
193. Squires, T. S. and M. Smith. 1979. Distribution and abundance of shortnose and Atlantic sturgeon in the Kennebec River estuary. Completion Report Project AFC-19. Maine Dep Marine Res, Augusta, ME. 53 pp.
194. Stevens, D. E. and L. W. Miller. 1970. Distribution of sturgeon larvae in the Sacramento-San Joaquin River system. *Calif Fish Game* 56(2):80-6.
195. Stockard, C. R. 1907. Observations on the natural history of *Polyodon spathula*. *Am Natl* 41(492):753-66.
196. Stockley, C. 1981. Columbia River sturgeon. *Prog Rep* 150. Wash Dep Fish. 28 pp.
197. Stone, L. 1900. The spawning habits of the lake sturgeon (*Acipenser rubicundus*). *Trans Am Fish Soc* 29:118-28.
198. Suzuki, K. and G. Nishi. 1976. Rearing of sturgeons in Japan. *Proc Japan-Soviet Joint Symp Aqua* 5:379-93.
199. Swallow, R. L. 1985. The effect of food deprivation on the plasma free amino acid levels of sturgeon, *Acipenser transmontanus*, in *N Am Sturgeons: Biol Aqua Potential*. F. P. Binkowski and S. I. Doroshov, eds. Dr. W. Junk Publishers, Dordrecht, p. 93-6.
200. Sytna, L. A. 1970. The duration of the individual development stages in the early postembryology of sturgeons. *J Ichthyol* 10(5):641-51.
201. Taubert, B. D. 1980. Reproduction of shortnose sturgeon (*Acipenser brevirostrum*) in the Holyoke Pool, Connecticut River, MA. *Copeia* 1:114-7.
202. Taubert, B. D. and M. J. Dadswell. 1980. Description of some larval shortnose sturgeon (*Acipenser brevirostrum*) from the Holyoke Pool, Connecticut River, MA, U.S.A., and the Saint John River, New Brunswick, Can. *Can J Zool* 58:1125-8.
203. Thuemler, T. F. 1985. The lake sturgeon, *Acipenser fulvescens*, in the Menominee River, Wisconsin-Michigan, in *N Am Sturgeons: Biol Aqua Potential*. F. P. Binkowski and S. I. Doroshov, eds. Dr. W. Junk Publishers, Dordrecht, p. 73-8.
204. Tsepkin, Ye. A. and L. I. Sokolov. 1971. The maximum size and age of some sturgeons. *J Ichthyol* 11(1):444-6.
205. Vasetskiy, S. G. 1971. Fishes of the family Polyodontidae. *J Ichthyol* 11(1):18-31.
206. Vasil'yev, V. P., L. I. Sokolov, and Ye. V. Serebryakova. 1980. Karyotypes of the Siberian sturgeon, *Acipenser baeri*, of the Lena River and some aspects of karyotype evolution in *Acipenseriformes*. *J Ichthyol* 20(6):37-45.
207. Vladykov, V. D. 1955a. Fishes of Quebec. Sturgeons. *Dep Fish Que Album* 5:11.
208. ——— 1955b. A comparison of Atlantic sea sturgeon with a new subspecies from the Gulf of Mexico (*Acipenser oxyrinchus desotoi*). *J Fish Res Bd Can* 12:754-61.
209. Vladykov, V. D. and G. Beaulieu. 1947. Etudes sur l'esturgeon (*Acipenser*) de la Province de Quebec. *Naturaliste Canadien* 73 (6-8):143-204.
210. Vladykov, V. D. and J. R. Greeley. 1963. Order Acipenseroides in Fishes of the Western North Atlantic. *Memoir, Sears Foundation for Marine Research, Number 1*. Yale Univ, New Haven, CT, p. 24-60.

211. Wales, J. H. 1946. Sturgeon from Lake Shasta. Calif Fish Game 32(1):31.
212. Wang, Y. L. 1984. The effect of temperature on the early development of white sturgeon and lake sturgeon. Unpublished Master's thesis, Univ Calif, Davis, CA. 54 pp.
213. Wang, Y. L., F. P. Binkowski, and S. I. Doroshov. 1985. Effect of temperature on early development of white and lake sturgeon, *Acipenser transmontanus* and *Acipenser fulvescens*, in N Am Sturgeons: Biol Aqua Potential. F. P. Binkowski and S. I. Doroshov, eds. Dr. W. Junk Publishers, Dordrecht, p. 43-50.
214. Washburn and Gillis Associates, Ltd. 1981. Studies of the early life history of the short-nose sturgeon (*Acipenser brevirostrum*). Final Rep to Northeast Utilities Serv. 120 pp.
215. Wedemeyer, G. A. 1977. Environmental requirements for fish health, in Proceedings of the International Symposium on Diseases of Cultured Salmonids. Tavolek, Inc., Seattle, WA. p. 41-55
216. Weisel, G. F. 1973. Anatomy and histology of the digestive system of the paddlefish (*Polyodon spathula*). J Morphol 140 (2):243-56.
217. Williams, J. E. 1951. The lake sturgeon. Mich Conserv 20(6):15-8.
218. Wooley, C. M. 1985. Evaluation of morphometric characters used in taxonomic separation of Gulf of Mexico sturgeon, *Acipenser oxyrinchus desotoi*, in N Am Sturgeons: Biol Aqua Potential. F. P. Binkowski and S. I. Doroshov, eds. Dr. W. Junk Publishers, Dordrecht, p. 97-104.

SECTION REFERENCES

INTRODUCTION

10, 14, 19-22, 24, 26, 51, 54, 63, 64, 72, 94, 114, 119, 144, 146, 147, 152, 158, 159, 168, 175, 179, 186-191

SECTION I: Distribution and Natural History . . .

General

21, 32, 44, 55, 63, 69, 70, 95, 105, 129, 156, 176, 183, 205, 207, 210

White Sturgeon

7, 8, 32, 36, 44, 55, 69, 70, 75, 95, 109, 111, 121, 145, 150, 151, 156, 170, 182, 183, 194, 196, 211

Green Sturgeon

36, 44, 55, 70, 75, 95, 120, 150, 156, 181, 183

Atlantic Sturgeon

23, 32, 55, 66, 67, 69, 91, 102, 138, 157, 183, 186, 187, 191, 207-210, 218

Lake Sturgeon

9, 32, 49, 55, 69, 90, 93, 94, 134-136, 139, 163, 176, 183, 197, 203, 207, 209, 210, 217

Shortnose Sturgeon

27, 32, 52, 55, 66, 67, 69, 74, 87-89, 131, 183, 187, 193, 201, 210

Shovelnose Sturgeon

32-34, 55, 69, 98, 99, 123, 155

Pallid Sturgeon

32-34, 55, 69, 104, 122

Paddlefish

31, 32, 69, 79, 80, 100, 101, 167, 169, 172, 195, 205, 216

SECTION II: Gamete Biology

37-42, 59, 60, 81, 82, 118, 141, 176

SECTION III: Embryology and Larval Development

White Sturgeon

17, 212, 213

Other Species

11, 12, 15, 58, 60, 68, 71, 83, 103, 167, 171, 178, 200, 202

SECTION IV: Broodstock Capture

47, 64, 72, 188-190

SECTION V: Broodstock Handling, Transport, and Holding

64, 72, 188-190

SECTION VI: Broodstock Evaluation: Field Examination

58, 64, 85

SECTION VII: Broodstock Evaluation: Hatchery

13, 56, 58, 62-65, 109, 126-128, 140, 152

SECTION VIII: Gamete Processing

62-64, 81, 82, 84, 113, 142, 152, 154

SECTION IX: Incubation of Eggs and Early Life Stages

5, 57, 62-64, 154

SECTION X: Fingerling Production

28-30, 43, 62-64, 86, 125, 153, 173, 174, 198

